

# Neon Round 360° 13 8,6W/m

Neon Round 360° 13 – 8.6 W/m IP65 is a neon LED strip with uniform 360° light emission, designed to create continuous lighting effects visible from any angle. Its 13 mm round profile and silicone housing provide flexibility, durability, and a high-quality finish, making it ideal for decorative, architectural, and signage applications, both indoors and outdoors



**Qualities**

- LED
- 
- 24V
- IP67
- ⌚ 55.000h
- McAdam C2

**Led Colour**

- 2.7K
- 3K
- 4K

**Regulation**

- NO DIM
- DALI
- 

**Beam Angle**

- 90°

**REF. CODE**

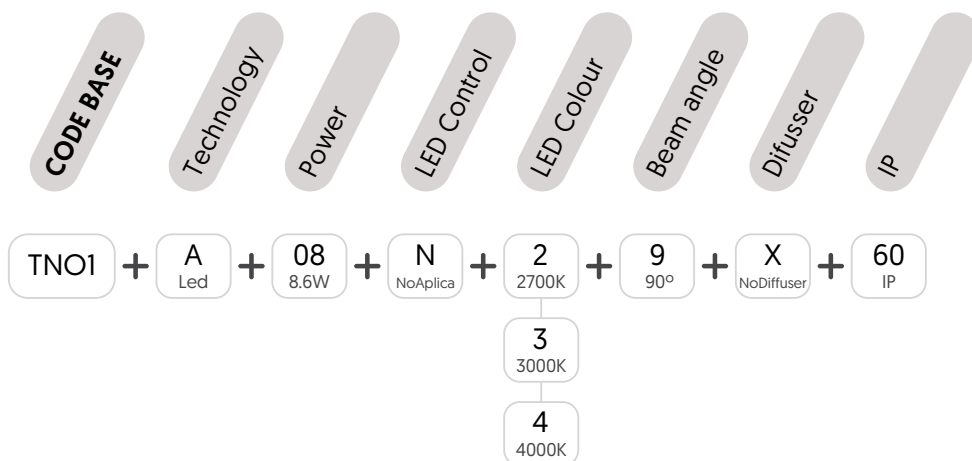

**PARAMETER**

	W	V	TEMP	LUM/m	CRI
<b>Neón Round 360° 13 8,6W/m</b>	8.6W	24V	2.700K	514	>90
			3.000K	518	
			4.000K	531	

## TEC. DRAWINGS

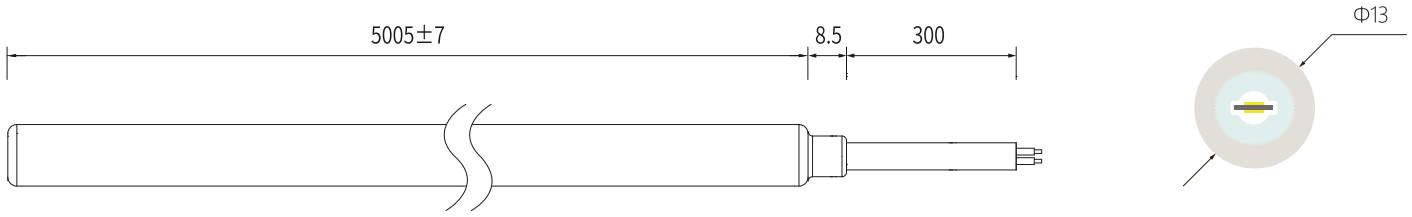

Cutting interval: 25mm

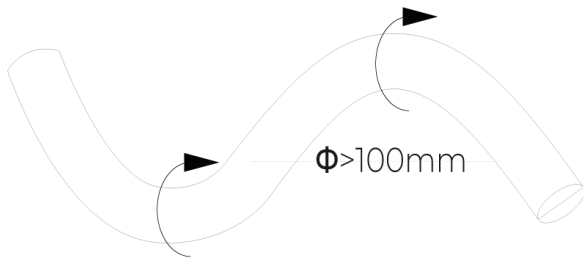

### Technical Data

<b>Model No.</b>	Neon Round 360° 13 – 8.6 W/m
<b>Dimension</b>	Ø13mm / Ø0.51in
<b>Voltage</b>	DC24V
<b>RA</b>	>90
<b>Dimming</b>	Dimmable
<b>Efficacy</b>	61.7LM/W @4000K
<b>Storage temperature</b>	-25~60°C / -22~140F
<b>Ambient Temperature</b>	Min.25°C Max.+55°C

### Light Distribution Curve

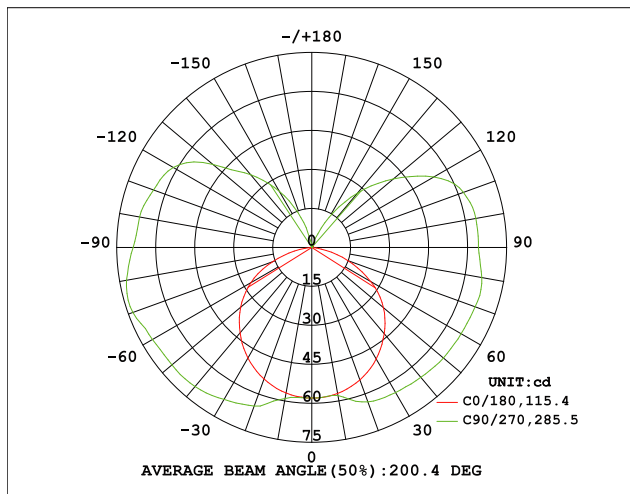

### Illuminance Curve

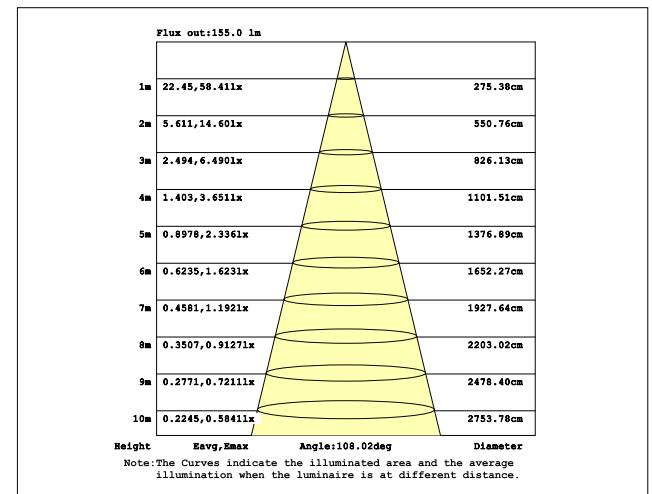

### Cable Lead Option



Front cable entry (standard)



Closed end cap

## Accessories (Unit: mm)

Aluminium Mounting clips

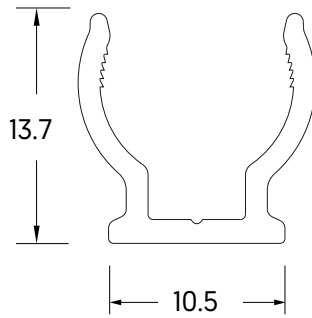
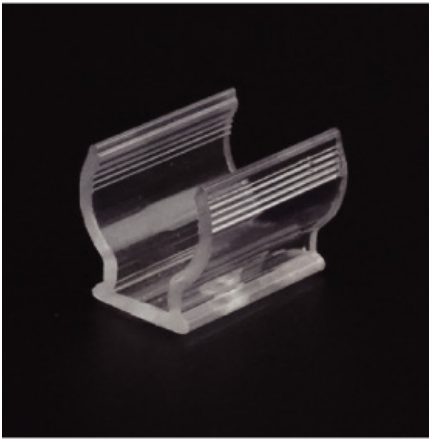

Length: 10.5x13.7

## Connection diagram

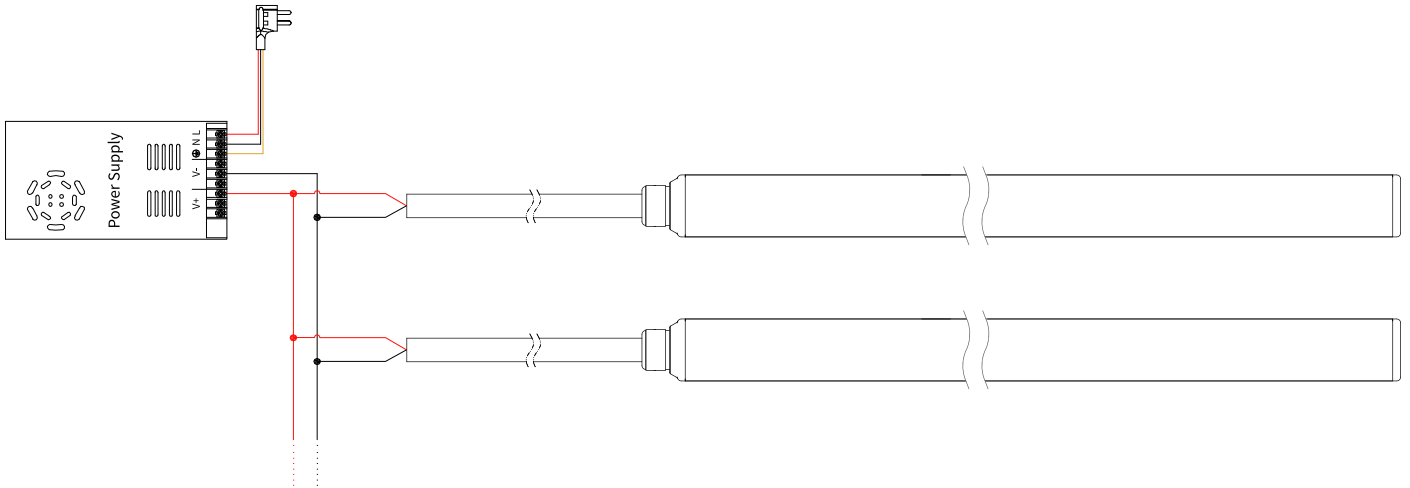

## Installation Precautions

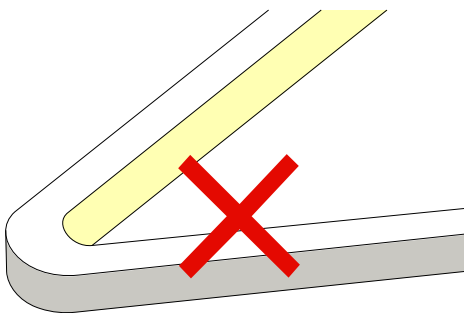

Small angle bending is prohibited

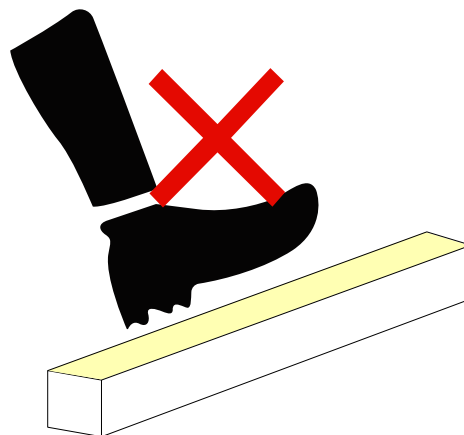

Prohibit trample