

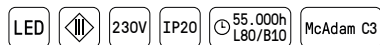

DARK 80

Discover perfection in lighting with Dark by Onok; Available in two different sizes, both square and rectangular, each with 4 light points, Dark offers focused light of exceptional intensity that transforms any space. Its clean and minimalist design, with straight and elegant lines, seamlessly integrates into any environment, adding a touch of modernity and distinction to each setting. It offers a low UGR, ensuring comfortable and glare-free lighting, providing a clean and pleasant visual experience.

Qualities



Led Colour



Regulation



Beam Angle



Finish



Diffuser



Installation



TEC. DRAWINGS

DARK 80 RECESSED

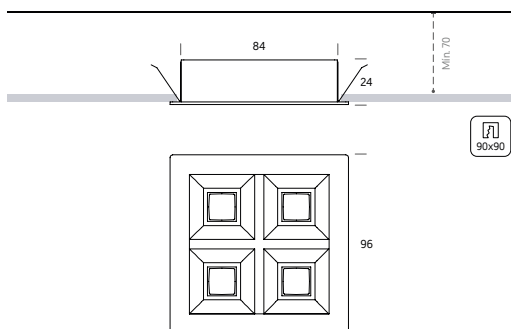

DARK 80 FRAMELESS

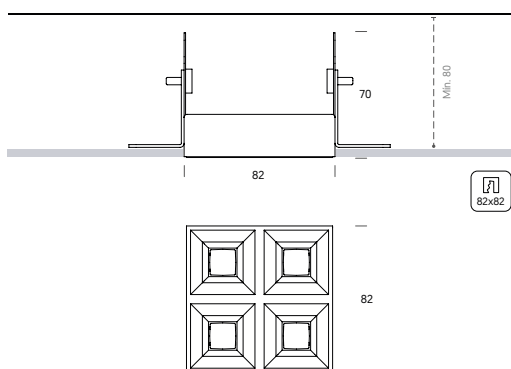

	W	mA	TEMP	LUM	CRI
DARK 80	5.6	500	3.000K	795	>90
			4.000K	840	

REF. CODE

