

CC LINEAR TERMINAL



COMFORTLINE TERMINAL L-R1

**186443, 186444, 186486, 186487, 186488,
186491, 186492, 186737**

Typical Applications

Built-in in linear luminaires for

- Office lighting

ComfortLine Terminal L-R1

- **SELECTABLE OUTPUT CURRENT
VIA CONNECTION TERMINAL**
- **VERY LOW RIPPLE CURRENT: < 1%**
- **LONG SERVICE LIFE:
UP TO 100,000 HRS.**
- **PRODUCT GUARANTEE: 5 YEARS**



ComfortLine Terminal L-R1

Product features

- Linear casing shape

Functions

- The required current output can be chosen by selecting the respective pin at the output terminal.

Electrical features

- Mains voltage: 220–240 V $\pm 10\%$
- Mains frequency: 50–60 Hz
- Push-in terminals: 0.2–1.5 mm²
- Power factor at full load: > 0.97
- Max. working voltage (U_{OUT}): 250 V
- Secondary side switching of LED modules is not allowed.

Safety features

- Protection against transient main peaks up to 1 kV (between L and N) and up to 2 kV (between L/N and PE)
- Electronic short-circuit protection
- Overtemperature protection
- Protection against "no load" operation
- Degree of protection: IP20
- Protection class I

Packaging units

Ref. No.	Packaging unit		Weight g
	Pieces per box	Boxes per pallet	
186443	20	48	250
186444	20	48	227
186486	20	48	250
186487	20	48	250
186488	20	48	250
186491	20	48	250
186492	20	48	250
186737	20	48	235



Applied standards

- EN 61347-1
- EN 61347-2-13
- EN 61547
- EN 61000-3-2
- EN 62384
- EN 55015



Dimensions

- Casing: M10
- Length: 359 mm
- Width: 30 mm
- Height: 21 mm

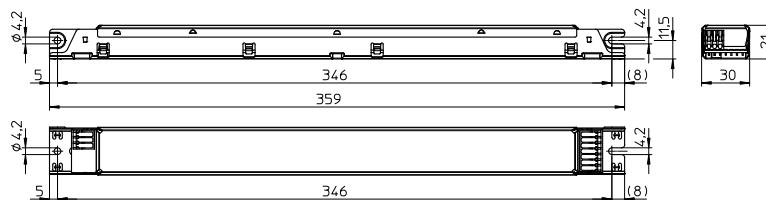

Product guarantee

- 5 years
- The conditions for the Product Guarantee of the Vossloh-Schwabe Group shall apply as published on our homepage (www.vossloh-schwabe.com). We will be happy to send you these conditions upon request.

The values contained in this data sheet can change due to technical innovations. Any such changes will be made without separate notification.

Electrical characteristics

Max. output W	Type	Ref. No.	Voltage 50–60 Hz V	Mains current mA	Inrush current A / μ s	Current output DC mA (\pm 5%)	Voltage output DC (V)	THD at full load % (230 V)	Efficiency at full load % (230 V)	Ripple 100 Hz %
27.5	ECXe 175.173	186486	220–240	150–140	24.4 / 242	125	155–220	< 15	> 90	< 1
33				175–165		150	130–220		> 91	
38.5				200–190		175	110–220		> 92	
40	ECXe 700.148	186444	220–240	200–190	25 / 250	350	57–114	< 11.5	> 90	< 1
				205–190		500	40–80		> 89	
				210–195		700	28–57		> 88	
44	ECXe 250.174	186487	220–240	220–205	24.4 / 242	200	112–220	< 13	> 93	< 1
47				230–220		225	104–208		> 92	
47				235–220		250	94–188		> 92	
46.8	ECXe 325.175	186488	220–240	235–220	24.4 / 242	275	85–170	< 17	> 91	< 1
46.8				235–220		300	78–156		> 91	
46.8				235–220		325	72–144		> 91	
77	ECXe 450.288	186737	220–240	390–355	31 / 270	350	100–220	< 14.4	> 94	< 1
84.8				420–385		400	100–212		> 94	
85.5				420–390		450	100–190		> 94	
79	ECXe 700.147	186443	220–240	400–370	30 / 285	350	120–225	< 16	> 94	< 1
84				420–390		500	80–170		> 93	
				420–390		700	60–120		> 92	
82.5	ECXe 425.178	186491	220–240	410–375	30.5 / 281	375	113–220	< 14.7	> 93	< 1
84.8				420–385		400	105–212		> 94	
85				420–390		425	100–200		> 94	
84.7	ECXe 650.179	186492	220–240	420–390	30.5 / 281	550	77–154	< 13.3	> 93	< 1
84.6				420–390		600	71–141		> 93	
85.1				420–390		650	65–131		> 93	

Maximum ratings

Exceeding the maximum ratings can lead to reduction of service life or destruction of the drivers.

Ref. No.	Ambient temperature range		Operation humidity range		Storage temperature range		Storage humidity range		Max. operation temperature at t_c point °C	Degree of protection
	°C min.	°C max.	% min.	% max.	°C min.	°C max.	% min.	% max.		
186443	-25	+50	5	60	-40	+85	5	95	+75 (at 350 mA) +75 (at 500 mA) +80 (at 700 mA)	IP20
186444	-25	+60	5	60	-40	+85	5	95	+75 (at 350 mA) +75 (at 500 mA) +80 (at 700 mA)	
186486	-25	+60	5	60	-40	+85	5	95	+70	
186487	-25	+60	5	60	-40	+85	5	95	+70	IP20
186488	-25	+60	20	60	-40	+85	5	95	+75	IP20
186491	-25	+50	5	60	-40	+85	5	95	+65	IP20
186492	-25	+50	5	60	-40	+85	5	95	+65 (at 550 mA) +70 (at 600 mA) +70 (at 650 mA)	IP20
186737	-25	+60	20	60	-40	+85	5	95	+75	

The values contained in this data sheet can change due to technical innovations. Any such changes will be made without separate notification.

Expected service life time

at operation temperatures at t_c point

Ref. No.	Operation current (mA)	Temperature	Service life hrs.	Temperature	Service life hrs.
186443	350	60 °C	100,000	70 °C	50,000
	500	65 °C	100,000	75 °C	50,000
	700	70 °C	100,000	80 °C	50,000
186444	350	65 °C	100,000	75 °C	50,000
	500	65 °C	100,000	75 °C	50,000
	700	70 °C	100,000	80 °C	50,000
186486	125	60 °C	100,000	70 °C	50,000
	150	60 °C	100,000	70 °C	50,000
	175	60 °C	100,000	70 °C	50,000
186487	200	60 °C	100,000	70 °C	50,000
	225	60 °C	100,000	70 °C	50,000
	250	60 °C	100,000	70 °C	50,000

Ref. No.	Operation current (mA)	Temperature	Service life hrs.	Temperature	Service life hrs.
186488	275	65 °C	100,000	75 °C	50,000
	300	65 °C	100,000	75 °C	50,000
	325	65 °C	100,000	75 °C	50,000
186491	375	55 °C	100,000	65 °C	50,000
	400	55 °C	100,000	65 °C	50,000
	425	55 °C	100,000	65 °C	50,000
186492	550	55 °C	100,000	65 °C	50,000
	600	60 °C	100,000	70 °C	50,000
	650	60 °C	100,000	70 °C	50,000
186737	350	65 °C	100,000	75 °C	50,000
	400	65 °C	100,000	75 °C	50,000
	450	65 °C	100,000	75 °C	50,000

Product labels

INPUT
U_N = 220...240 V~
 I_N = 420...390 mA
 f_N = 50...60 Hz
 λ = 0,95...0,98

VS LIGHTING SOLUTIONS
 Vossloh-Schwabe Deutschland GmbH
 Stuttgarter Straße 61/1, 73614 Schorndorf
 Electronic converter for LED
Type ECxEx 700.147
 Ref.-No. 186443
 Made in Serbia (Europe)

EN 61347-1
 EN 61347-2:13
 EN 62384
 EN 61547
 EN 55015
 EN 61000-3-2

OUTPUT		
I _{out} (mA)	U _{out} (V)	P _{out} (W)
350	60...120	60...120
500	40...85	42...85
700	20...40	20...40

t_c (°C) 70 75 80
 t_a (°C) -25...+50
 U_{iso} (V) <250

OUTPUT —
 ● I_c 350mA —
 ● 500mA —
 ● 700mA —

Non isolated

INPUT
U_N = 220...240 V~
 I_N = 210...200 mA
 f_N = 50...60 Hz
 λ = 0,95...0,98

VS LIGHTING SOLUTIONS
 Vossloh-Schwabe Deutschland GmbH
 Stuttgarter Straße 61/1, 73614 Schorndorf
 Electronic converter for LED
Type ECxEx 700.148
 Ref.-No. 186444
 Made in Serbia (Europe)

EN 61347-1
 EN 61347-2:13
 EN 62384
 EN 61547
 EN 55015
 EN 61000-3-2

OUTPUT		
I _{out} (mA)	U _{out} (V)	P _{out} (W)
350	60...120	60...120
500	40...80	28...57
700	20...40	20...40

t_c (°C) 75 75 80
 t_a (°C) -25...+60
 U_{iso} (V) <250

OUTPUT —
 ● I_c 350... —
 ● 500... —
 ● 700... —

C-034H Non isolated

INPUT
U_N = 220...240 V~
 I_N = 200...190 mA
 f_N = 50...60 Hz
 λ = 0,95...0,98

VS LIGHTING SOLUTIONS
 Vossloh-Schwabe Deutschland GmbH
 Stuttgarter Straße 61/1, 73614 Schorndorf
 Electronic converter for LED
Type ECxEx 175.173
 Ref.-No. 186486
 Made in Serbia (Europe)

EN 61347-1
 EN 61347-2:13
 EN 62384
 EN 61547
 EN 55015
 EN 61000-3-2

OUTPUT		
I _{out} (mA)	U _{out} (V)	P _{out} (W)
175	150 125	125 125
150	110...220	130...220
125	20...33	20...27

t_c (°C) 70
 t_a (°C) -25...+60
 U_{iso} (V) <250

OUTPUT —
 ● I_c 125... —
 ● 150... —
 ● 175... —

C-053H Non isolated

INPUT
U_N = 220...240 V~
 I_N = 235...220 mA
 f_N = 50...60 Hz
 λ = 0,95...0,98

VS LIGHTING SOLUTIONS
 Vossloh-Schwabe Deutschland GmbH
 Stuttgarter Straße 61/1, 73614 Schorndorf
 Electronic converter for LED
Type ECxEx 250.174
 Ref.-No. 186487
 Made in Serbia (Europe)

EN 61347-1
 EN 61347-2:13
 EN 62384
 EN 61547
 EN 55015
 EN 61000-3-2

OUTPUT		
I _{out} (mA)	U _{out} (V)	P _{out} (W)
250	225 200	200 200
225	94...188	104...208
200	23...47	23...44

t_c (°C) 70
 t_a (°C) -25...+60
 U_{iso} (V) <250

OUTPUT —
 ● I_c 200... —
 ● 225... —
 ● 250... —

C-053H Non isolated

INPUT
U_N = 220...240 V~
 I_N = 235...220 mA
 f_N = 50...60 Hz
 λ = 0,95...0,98

VS LIGHTING SOLUTIONS
 Vossloh-Schwabe Deutschland GmbH
 Stuttgarter Straße 61/1, 73614 Schorndorf
 Electronic converter for LED
Type ECxEx 325.175
 Ref.-No. 186488
 Made in Serbia (Europe)

EN 61347-1
 EN 61347-2:13
 EN 62384
 EN 61547
 EN 55015
 EN 61000-3-2

OUTPUT		
I _{out} (mA)	U _{out} (V)	P _{out} (W)
325	300 275	275 275
300	72...144	78...156
275	24...47	24...47

t_c (°C) 70
 t_a (°C) -25...+60
 U_{iso} (V) <250

OUTPUT —
 ● I_c 275... —
 ● 300... —
 ● 325... —

C-053H Non isolated

INPUT
U_N = 220...240 V~
 I_N = 420...390 mA
 f_N = 50...60 Hz
 λ = 0,95...0,98

VS LIGHTING SOLUTIONS
 Vossloh-Schwabe Deutschland GmbH
 Stuttgarter Straße 61/1, 73614 Schorndorf
 Electronic converter for LED
Type ECxEx 425.178
 Ref.-No. 186491
 Made in Serbia (Europe)

EN 61347-1
 EN 61347-2:13
 EN 62384
 EN 61547
 EN 55015
 EN 61000-3-2

OUTPUT		
I _{out} (mA)	U _{out} (V)	P _{out} (W)
425	400 375	375 375
400	100...200	105...212
375	43...85	42...85

t_c (°C) 65
 t_a (°C) -25...+50
 U_{iso} (V) <250

OUTPUT —
 ● I_c 375... —
 ● 400... —
 ● 425... —

Non isolated

INPUT
U_N = 220...240 V~
 I_N = 420...390 mA
 f_N = 50...60 Hz
 λ = 0,95...0,98

VS LIGHTING SOLUTIONS
 Vossloh-Schwabe Deutschland GmbH
 Stuttgarter Straße 61/1, 73614 Schorndorf
 Electronic converter for LED
Type ECxEx 650.179
 Ref.-No. 186492
 Made in Serbia (Europe)

EN 61347-1
 EN 61347-2:13
 EN 62384
 EN 61547
 EN 55015
 EN 61000-3-2

OUTPUT		
I _{out} (mA)	U _{out} (V)	P _{out} (W)
650	600 550	550 550
600	65...131	71...141
550	43...85	43...84

t_c (°C) 70 70 65
 t_a (°C) -25...+50
 U_{iso} (V) <250

OUTPUT —
 ● I_c 550... —
 ● 600... —
 ● 650... —

Non isolated

INPUT
U_N = 220...240 V~
 I_N = 420...390 mA
 f_N = 50...60 Hz
 λ = 0,95...0,98

VS LIGHTING SOLUTIONS
 Vossloh-Schwabe Deutschland GmbH
 Stuttgarter Straße 61/1, 73614 Schorndorf
 Electronic converter for LED
Type ECxEx 450.288
 Ref.-No. 186737
 Made in Serbia (Europe)

EN 61347-1
 EN 61347-2:13
 EN 62384
 EN 61547
 EN 55015
 EN 61000-3-2

OUTPUT		
I _{out} (mA)	U _{out} (V)	P _{out} (W)
450	400 350	350 350
400	100...190	100...212
350	45...85	40...85

t_c (°C) 75
 t_a (°C) -25...+60
 U_{iso} (V) <250

OUTPUT —
 ● I_c 350mA —
 ● 400mA —
 ● 450mA —

Non isolated

The values contained in this data sheet can change due to technical innovations. Any such changes will be made without separate notification.

Typ. performance graphs for 186443 / Type ECXe 700.147

Working area

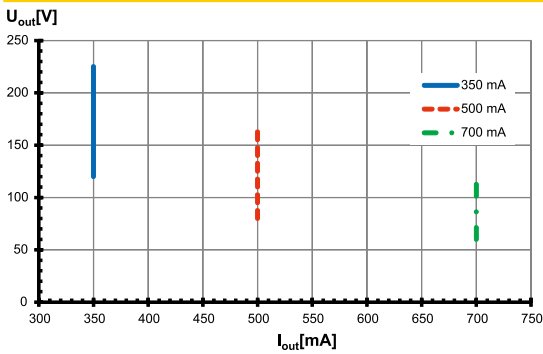

Efficiency

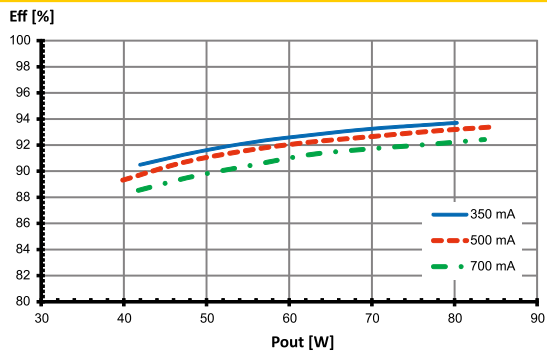

Power factor

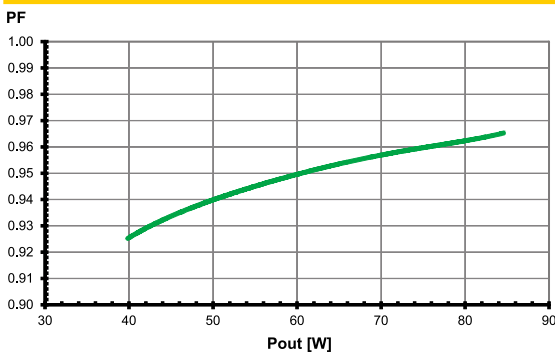

Total harmonic factor (THD)

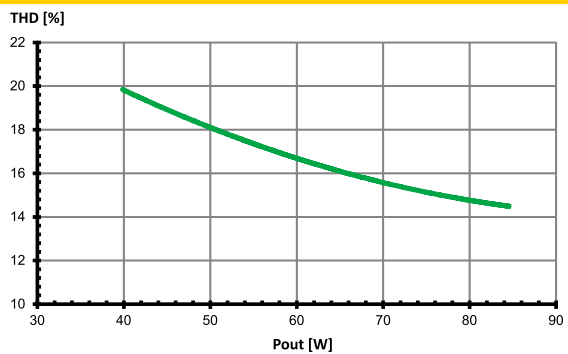

Typ. performance graphs for 186444 / Type ECXe 700.148

Working area

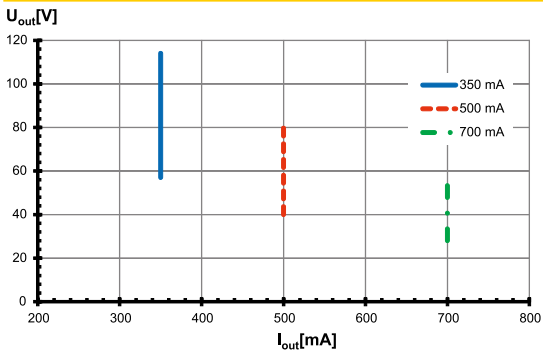

Efficiency

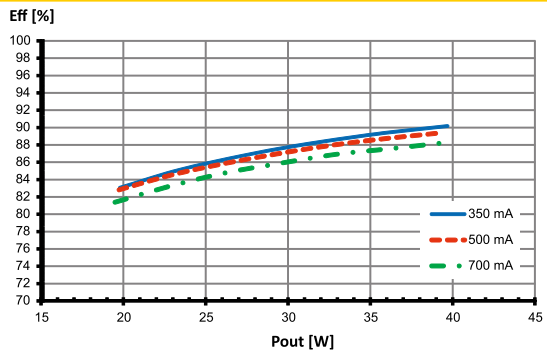

Power factor

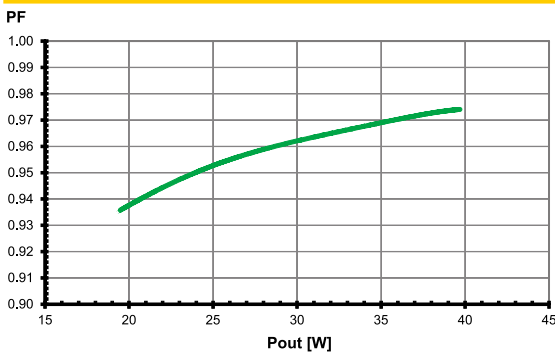

Total harmonic factor (THD)

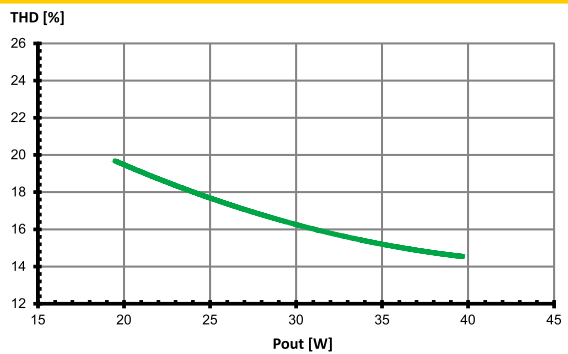

The values contained in this data sheet can change due to technical innovations. Any such changes will be made without separate notification.

Typ. performance graphs for 186486 / Type ECXe 175.173

Working area

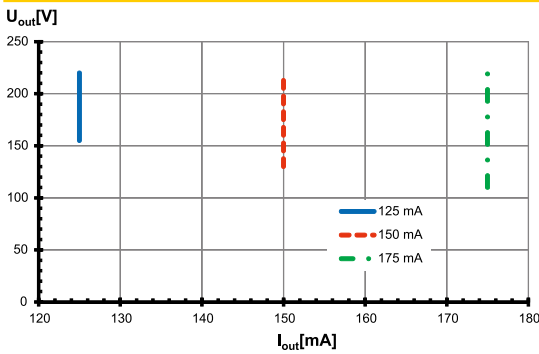

Efficiency

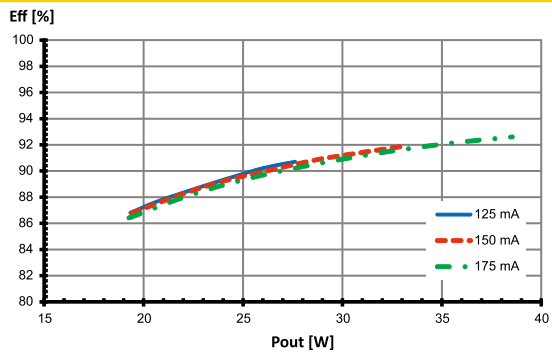

Power factor

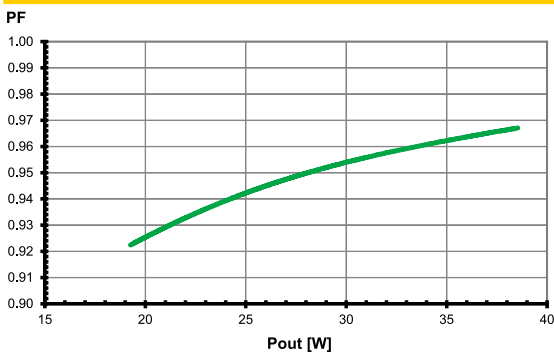

Total harmonic factor (THD)

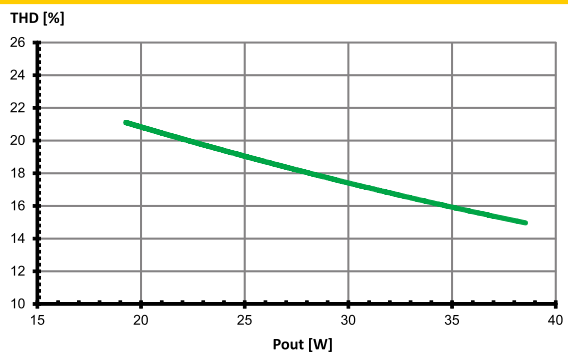

Typ. performance graphs for 186487 / Type ECXe 250.174

Working area

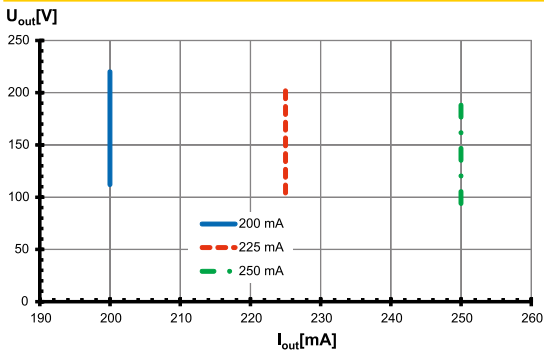

Efficiency

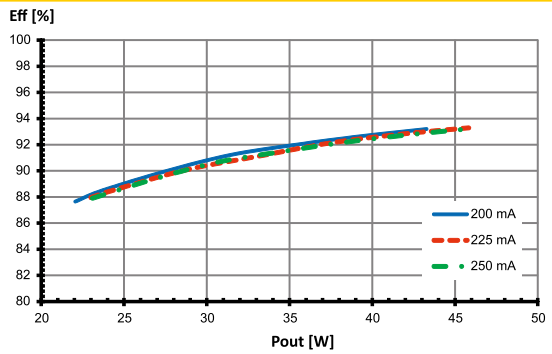

Power factor

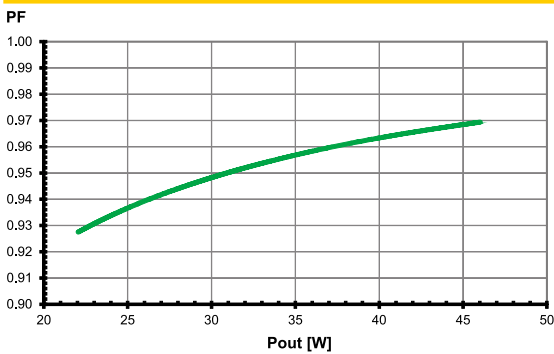

Total harmonic factor (THD)

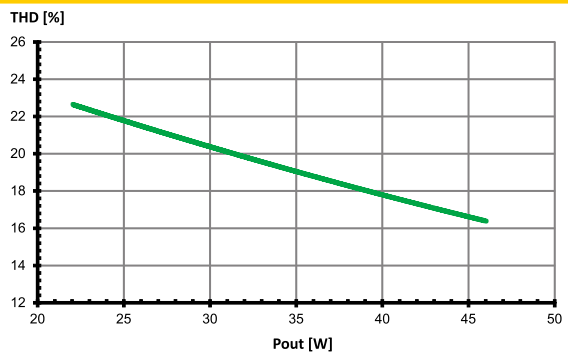

The values contained in this data sheet can change due to technical innovations. Any such changes will be made without separate notification.

Typ. performance graphs for 186488 / Type ECXe 325.175

Working area

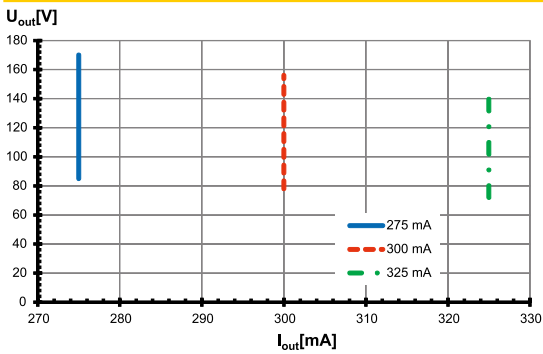

Efficiency

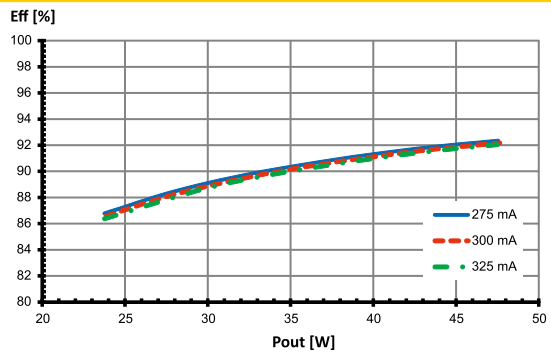

Power factor

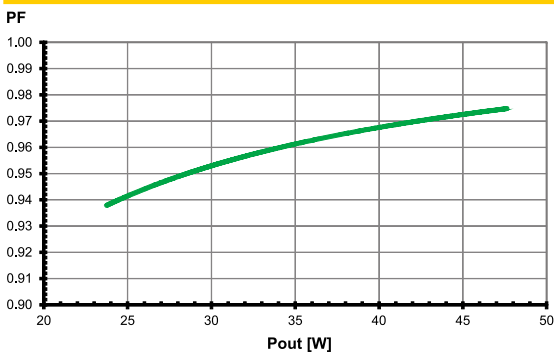

Total harmonic factor (THD)

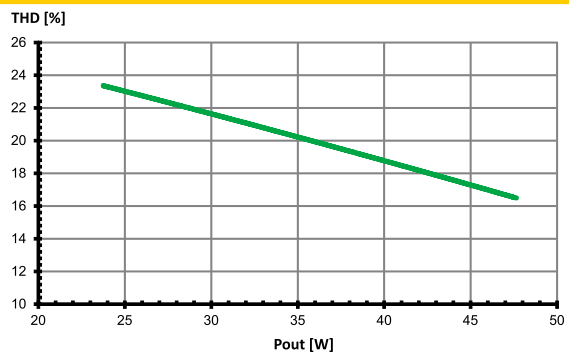

Typ. performance graphs for 186491 / Type ECXe 425.178

Working area

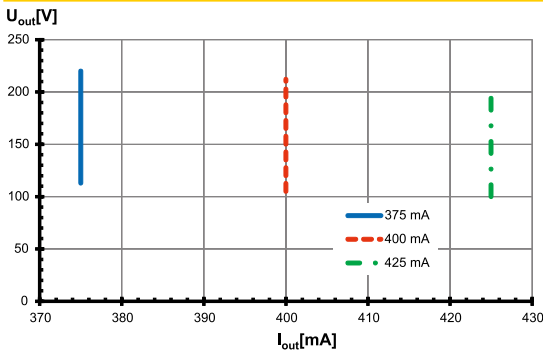

Efficiency

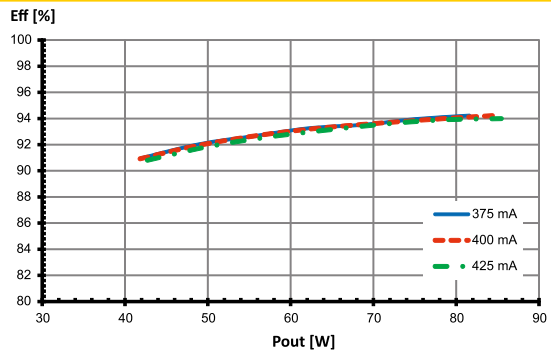

Power factor

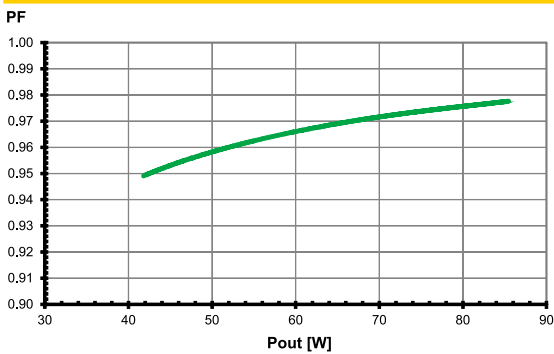

Total harmonic factor (THD)

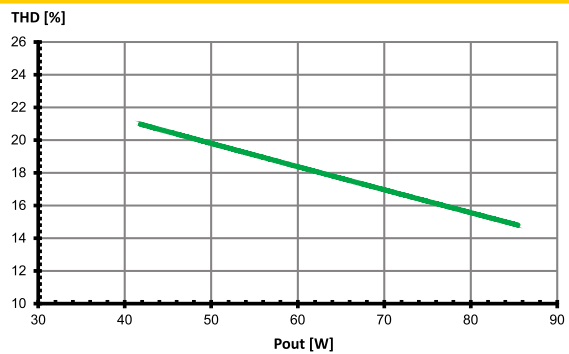

The values contained in this data sheet can change due to technical innovations. Any such changes will be made without separate notification.

Typ. performance graphs for 186492 / Type ECXe 650.179

Working area

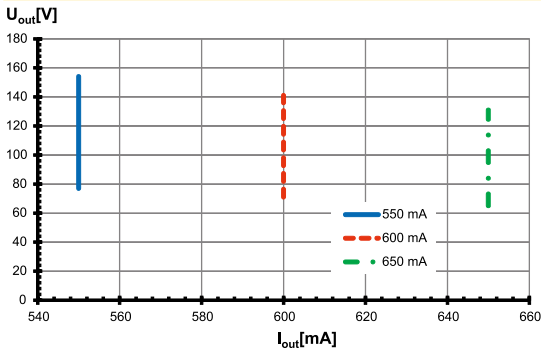

Efficiency

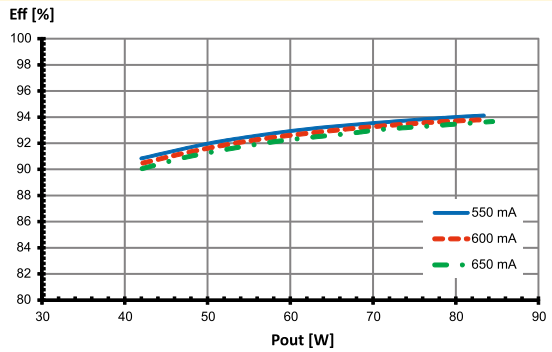

Power factor

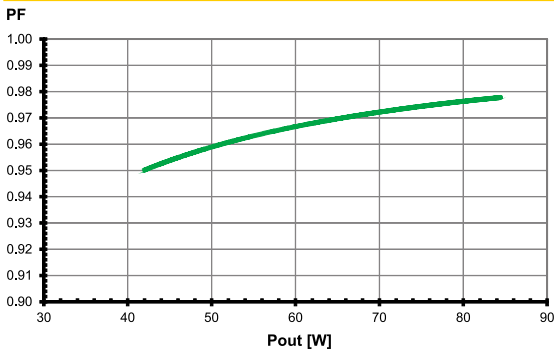

Total harmonic factor (THD)

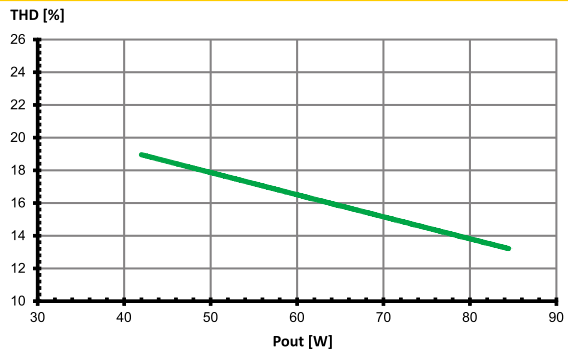

Typ. performance graphs for 186737 / Type ECXe 450.288

Working area

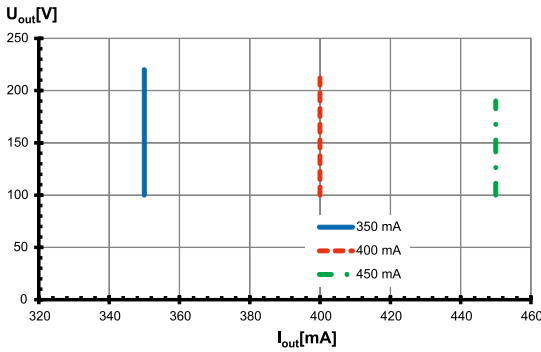

Efficiency

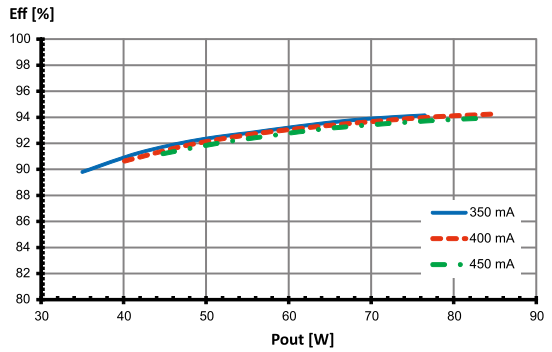

Power factor

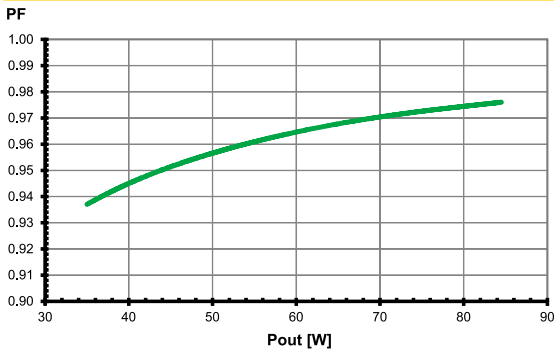

Total harmonic factor (THD)

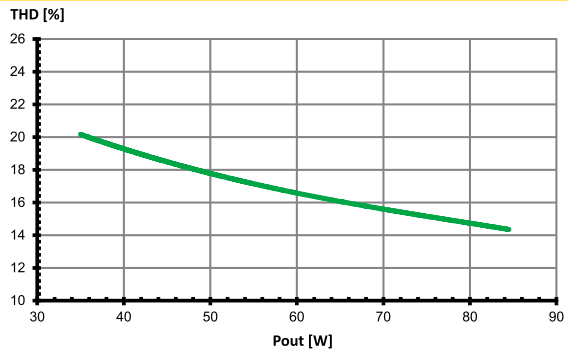

The values contained in this data sheet can change due to technical innovations. Any such changes will be made without separate notification.

Safety functions

- Transient mains peaks protection:
Values are in compliance with EN 61547 (interference immunity).
Surges between L–N: up to 1 kV
Surges between L/N–PE: up to 2 kV
- Short-circuit protection: The control gear is protected against permanent short-circuit with automatic restart function.
- Overload protection: The control gear only works in range of rated output power and voltage problemfree.
Please check before switch-on mains power supply that the selected LED load is suitable (see Electrical Characteristics on data sheet).
- Overheating: The control gear has overheating protection acc. to IEC 61347-1 C 5e).
In case of overheating the control gear will shut down. For restart switch of the mains for 1 min. and start again.
- No load operation: The control gear is protected against no load operation (open load).
- If any of the above mentioned safety functions will be triggered, disconnect the control gear from the power supply then find and eliminate the cause of the problem.

Output voltage (U_{OUT})

According to EN 61347-1, U_{OUT} indicates which voltage can occur at the output terminals directly or between the output terminals and the PE terminal of the LED driver. This value is given for non-insulated drivers.

The used LED module must have an insulation voltage that is at least as high as the specified U_{OUT} voltage of the driver.

Leakage current

Leakage currents are present in all electronic converters or luminaires with PE connection and must be observed especially when using non-insulated LED drivers.

The PCB surfaces of LED modules form a capacitance with grounded LED aluminum circuit boards, heat sinks or mounting plates. This leads to capacitive leakage currents between the connection poles of the LED (+ and –) and the PE terminal. These capacitances should be kept as small as possible, since they are responsible for a possible glowing or flickering of the LEDs in standby mode. In extreme cases, the maximum permissible leakage current of the luminaire according to EN 60598 paragraph 10.3 may be exceeded. The leakage current is also relevant when using RCD circuit breakers.

The values contained in this data sheet can change due to technical innovations. Any such changes will be made without separate notification.

Assembly and Safety Information

Installation must be carried out under observation of the relevant regulations and standards. Installation must be carried out in a voltage-free state (i.e. disconnection from the mains). The following advices must be observed; non-observance can result in the destruction of the LED drivers, fire and/or other hazards.

Mandatory regulations

- DIN VDE 0100
- EN 60598-1

Mechanical mounting

- Mounting position: Built-in: Any position inside a luminaire is allowed
Independent application: Drivers are not allowed to use for independent applications
- Mounting location: LED drivers are designed for integration into luminaires or comparable devices.
Installation in outdoor luminaires: degree of protection for luminaire with water protection rate ≥ 4 (e.g. IP54 required).
- Degree of protection: IP20
- Clearance: Min. 0.10 m from walls, ceilings and insulation
- Surface: Solid and plane surface for optimum heat dissipation required.
- Heat transfer: If the driver is destined for installation in a luminaire, sufficient heat transfer must be ensured between the driver and the luminaire casing. LED drivers should be mounted with the greatest possible clearance to heat sources. During operation the temperature measure at the driver's t_c point must not exceed the specified maximum value.
- Fastening: Using M4 screws in the designated holes
- Tightening torque: 0.2 Nm

Electrical installation

- Connection terminals: Push-in terminals for rigid or flexible conductors with a section of 0.2–1.5 mm²
- Stripped length: 8.5–10 mm
- Wiring: The mains conductor within the luminaire must be kept short (to reduce the induction of interference). Mains and lamp conductors must be kept separate and if possible should not be laid in parallel to one another.
- Polarity: Please ensure the correct polarity of the leads prior to commissioning. Reversed polarity can destroy the modules.
- Through-wiring: Is not allowed.
- Secondary load: The sum of forward voltages of LED loads has to be within the tolerances which are mentioned in the table "Electrical Characteristics" in this data sheet.

Wiring diagram:

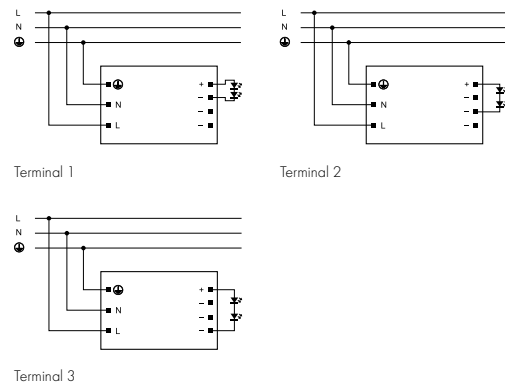

Selection of automatic cut-outs for VS LED drivers

- Dimensioning automatic cut-outs
High transient currents occur when an LED driver is switched on because the capacitors have to load. Ignition of LED modules occurs almost simultaneously. This also causes a simultaneous high demand for power. These high currents when the system is switched on put a strain on the automatic conductor cut-outs, which must be selected and dimensioned to suit.
- Release reaction
The release reaction of the automatic conductor cut-outs comply with VDE 0641, part 11, for B, C characteristics. The values shown in the following tables are for guidance purposes only and are subject to system-dependent change.
- No. of LED drivers
The maximum number of VS LED drivers applies to cases where the devices are switched on simultaneously. Specifications apply to single-pole fuses. The number of permissible drivers must be reduced by 20% for multi-pole fuses. The considered circuit impedance equals 400 m Ω (approx. 20 m [2.5 mm²] of conductor from the power supply to the distributor and a further 15 m to the luminaire).

Type	Ref. No.	Automatic cut-out type and possible no. of VS drivers pcs.					
		Cut-out type B			Cut-out type C		
		B 10 A	B 13 A	B 16 A	C 10 A	C 13 A	C 16 A
ECXe 700.147	186443	9	12	15	15	20	24
ECXe 700.148	186444	12	16	20	21	28	34
ECXe 175.173	186486	12	16	20	21	28	34
ECXe 250.174	186487	12	16	20	21	28	34
ECXe 325.175	186488	12	16	20	21	28	34
ECXe 425.178	186491	9	12	15	15	20	24
ECXe 650.179	186492	9	12	15	15	20	24
ECXe 450.288	186737	9	12	15	16	20	25

- To limit capacitive inrush currents the current carrying capacity of each circuit breaker (fuse) can be increased by a factor of 2.5 with the help of our ESB (Ref. No.: 149820, 149821, 149822) inrush current limiters.

The values contained in this data sheet can change due to technical innovations. Any such changes will be made without separate notification.