

Bridgelux® Gen 7 V10 Array Series

Product Data Sheet DS100



Introduction

V Series



The V Series™ LED Array products deliver high quality light in a compact and cost-effective solid-state lighting package. These chip on board (CoB) arrays can be efficiently driven at twice the nominal drive current, enabling design flexibility not previously possible. This high flux density light source is designed to support a wide range of high quality, low cost directional luminaires and replacement lamps for commercial and residential applications.

The V10 LED array is available in a variety of electrical, CCT and CRI combinations providing substantial design flexibility and energy efficiencies.

Lighting system designs incorporating these LED arrays deliver increased system level efficacy and longer service life. Typical applications include, replacement lamps, and task, accent, spot, track, wide area, security, wall pack and down lights.

Bridgelux Décor Series is our state of the art color line designed specifically for premium applications, producing unmatched LED light quality with brilliant color-rendering options and offer pleasing and inspiring lighting palettes. Bridgelux Décor Series color points are available on Vero® SE Series, Vero® Series, V Series™ and H Series™.

Décor Series Class A is based on human response testing, providing color points with a combined GAI and CRI metric.

Décor Series™ Ultra products provide a high CRI of 97 and a minimum R9 value of 93, which emphasizes the reds and color tones to which the human eye is most receptive - perfect for the most luxurious retail shops and world renowned museums. Décor Series Ultra is designed as a replacement for halogen.

Décor Series™ Street and Landmark is designed to be a direct replacement for high pressure sodium lamps.

Décor Series™ Showcase is the optimal solution for replacing ceramic metal halide lamps, incorporating the same pure white light with enhanced spectrum coverage and higher efficacy.

Features

- Efficacy of 150 lm/W typical
- Compact high flux density light source
- Uniform high quality illumination
- Minimum 65, 70, 80 and 90 and 95 CRI options
- Streamlined thermal path
- ENERGY STAR® / ANSI compliant color binning structure with 3 SDCM and 4 SDCM options
- More energy efficient than incandescent, halogen and fluorescent lamps
- Low voltage DC operation
- Instant light with unlimited dimming
- V_f bin code backside marking

Benefits

- Enhanced optical control
- Clean white light without pixilation
- High quality true color reproduction
- Significantly reduced thermal resistance and increased operating temperatures
- Uniform consistent white light
- Lower operating costs
- Easy to use with daylight and motion detectors to enable increased energy savings
- Reduced maintenance costs
- Environmentally friendly, no disposal issue



Contents

Product Feature Map	2
Product Nomenclature	2
Product Selection Guide	3
Performance at Commonly Used Drive Currents	7
Electrical Characteristics	12
Eye Safety	13
Absolute Maximum Ratings	14
Performance Curves	15
Typical Radiation Pattern	18
Typical Color Spectrum	19
Mechanical Dimensions	20
Color Binning Information	21
Packaging and Labeling	22
Design Resources	24
Precautions	24
Disclaimers	24
About Bridgelux	25

Product Feature Map

Bridgelux arrays are fully engineered devices that provide consistent thermal and optical performance on an engineered mechanical platform. The V Series arrays are the most compact chip-on-board devices across all of

Bridgelux's LED Array products. The arrays incorporate several features to simplify design integration and assembly. Please visit www.bridgelux.com for more information on the V Series family of products.

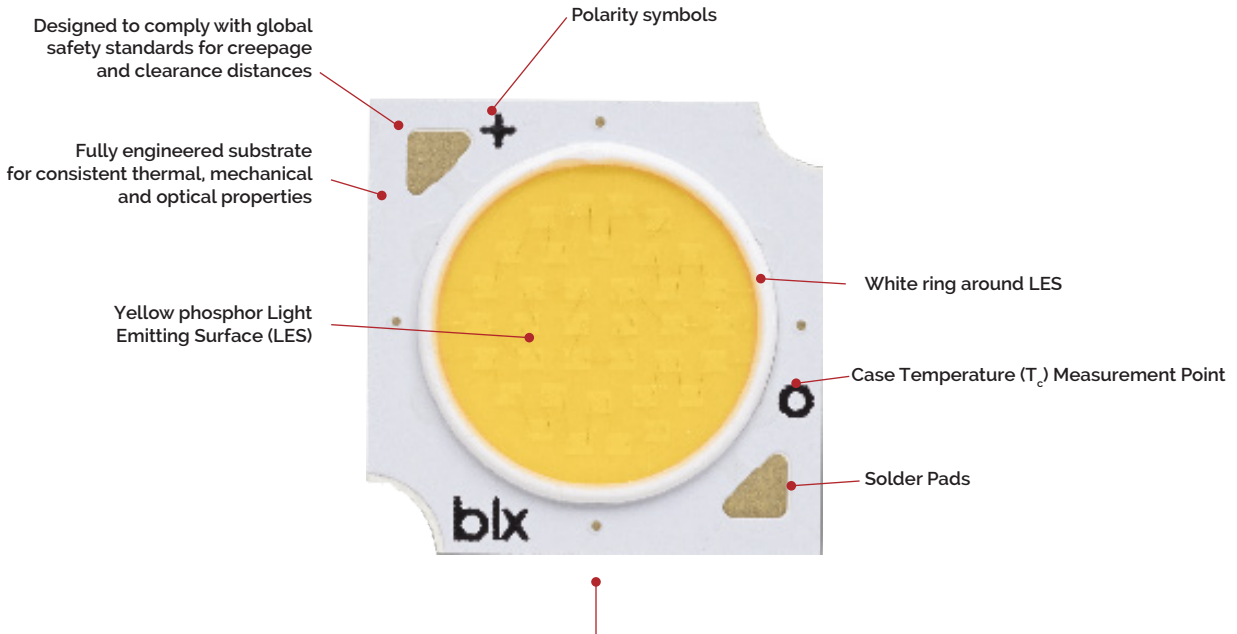

Note: Part number and lot codes are scribed on back of array

Product Nomenclature

The part number designation for Bridgelux V Series LED arrays is explained as follows:

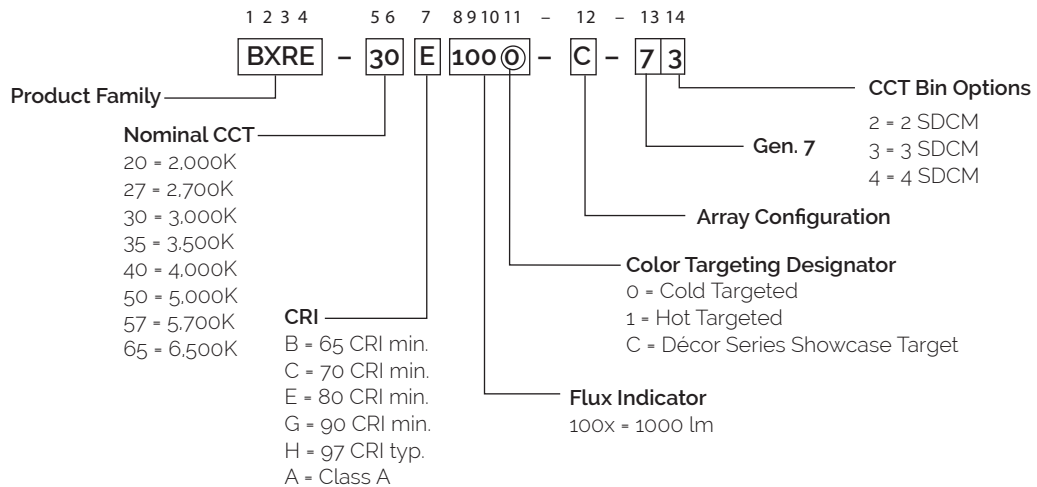

Product Selection Guide

The following product configurations are available:

Table 1: Selection Guide, Pulsed Measurement Data ($T_j = T_c = 25^\circ\text{C}$)

Part Number	Nominal CCT ¹ (K)	CRI ²	Nominal Drive Current ³ (mA)	Typical Pulsed Flux ^{4,5,6} $T_c = 25^\circ\text{C}$ (lm)	Minimum Pulsed Flux ^{6,7} $T_c = 25^\circ\text{C}$ (lm)	Typical V_f (V)	Typical Power (W)	Typical Efficacy (lm/W)
BXRE-20B1000-B-73	2000	65	270	1337	1177	34.8	9.4	141
BXRE-27E1000-B-7x	2700	80	270	1348	1187	34.8	9.4	144
BXRE-27E1000-C-7x	2700	80	360	1797	1581	34.8	12.5	143
BXRE-27G1000-B-7x	2700	90	270	1124	989	34.8	9.4	120
BXRE-27G1000-C-7x	2700	90	360	1498	1318	34.8	12.5	120
BXRE-27H1000-B-7x	2700	97	270	983	865	34.8	9.4	105
BXRE-30E1000-B-7x	3000	80	270	1418	1247	34.8	9.4	151
BXRE-30E1000-C-7x	3000	80	360	1890	1663	34.8	12.5	151
BXRE-30G1000-B-7x	3000	90	270	1177	1036	34.8	9.4	125
BXRE-30G1000-C-7x	3000	90	360	1569	1381	34.8	12.5	125
BXRE-30G100C-B-73	3000	90	270	1096	964	34.8	9.4	116
BXRE-30G100C-C-73	3000	90	360	1462	1287	34.8	12.5	116
BXRE-30A1001-B-73 ^{8,9}	3000	93	270	1096	964	34.8	9.4	116
BXRE-30A1001-C-73 ^{8,9}	3000	93	360	1462	1287	34.8	12.5	116
BXRE-30H1000-B-7x	3000	97	270	1049	923	34.8	9.4	112
BXRE-35E1000-B-7x	3500	80	270	1447	1273	34.8	9.4	154
BXRE-35E1000-C-7x	3500	80	360	1928	1697	34.8	12.5	154
BXRE-35G1000-B-7x	3500	90	270	1208	1063	34.8	9.4	129
BXRE-35G1000-C-7x	3500	90	360	1610	1417	34.8	12.5	129
BXRE-35A1001-B-73 ^{8,9}	3500	93	270	1162	1023	34.8	9.4	124
BXRE-35A1001-C-73 ^{8,9}	3500	93	360	1550	1364	34.8	12.5	124
BXRE-40E1000-B-7x	4000	80	270	1461	1285	34.8	9.4	155
BXRE-40E1000-C-7x	4000	80	360	1947	1713	34.8	12.5	155
BXRE-40G1000-B-7x	4000	90	270	1250	1100	34.8	9.4	133
BXRE-40G1000-C-7x	4000	90	360	1666	1466	34.8	12.5	133
BXRE-50C1001-B-7x	5000	70	270	1601	1409	34.8	9.4	170
BXRE-50C1001-C-7x	5000	70	360	2134	1878	34.8	12.5	170
BXRE-50E1001-B-7x	5000	80	270	1505	1324	34.8	9.4	160
BXRE-50E1001-C-7x	5000	80	360	2006	1765	34.8	12.5	160
BXRE-50G1001-B-7x	5000	90	270	1281	1127	34.8	9.4	136
BXRE-50G1001-C-7x	5000	90	360	1707	1502	34.8	12.5	136
BXRE-57C1001-B-7x	5700	70	270	1545	1360	34.8	9.4	164

Notes for Table 1:

- Nominal CCT as defined by ANSI C78.377-2011. Products with a CCT of 5000K-6500K are hot targeted to $T_c = 85^\circ\text{C}$.
- CRI values are typical for Decor Series Ultra and Decor Series Class A products. CRI values are minimums for all other products. Minimum Rg value for 80 CRI products is 0, the minimum Rg values for 90 CRI products is 50, the minimum Rg values for 97 CRI products is 93. Bridgelux maintains a ± 3 tolerance on Rg values.
- Drive current is referred to as nominal drive current.
- Products tested under pulsed condition (10ms pulse width) at nominal test current where T_j (junction temperature) - T_c (case temperature) = 25°C .
- Typical performance values are provided as a reference only and are not a guarantee of performance.
- Bridgelux maintains a $\pm 7\%$ tolerance on flux measurements.
- Minimum flux values at the nominal test current are guaranteed by 100% test.
- Nominal CCT is defined by the Lighting Research Center's Class A definition. The center of the Class A color bin is on the corresponding isothermal line.
- GAI value is 80. To help ensure optimal fixture level performance, GAI is measured at the fixture level, on axis, at a case temperature of 70°C . GAI may vary depending on fixture design and performance.

Product Selection Guide

Table 1: Selection Guide, Pulsed Measurement Data ($T_j = T_c = 25^\circ\text{C}$)

Part Number	Nominal CCT ¹ (K)	CRI ²	Nominal Drive Current ³ (mA)	Typical Pulsed Flux ^{4,5,6} $T_c = 25^\circ\text{C}$ (lm)	Minimum Pulsed Flux ^{6,7} $T_c = 25^\circ\text{C}$ (lm)	Typical V_f (V)	Typical Power (W)	Typical Efficacy (lm/W)
BXRE-57C1001-C-7x	5700	70	360	2059	1812	34.8	12.5	164
BXRE-57E1001-B-7x	5700	80	270	1531	1347	34.8	9.4	163
BXRE-57E1001-C-7x	5700	80	360	2040	1796	34.8	12.5	163
BXRE-65C1001-B-7x	6500	70	270	1573	1384	34.8	9.4	167
BXRE-65C1001-C-7x	6500	70	360	2097	1845	34.8	12.5	167
BXRE-65E1001-B-7x	6500	80	270	1559	1372	34.8	9.4	166
BXRE-65E1001-C-7x	6500	80	360	2078	1829	34.8	12.5	166

Notes for Table 1:

- Nominal CCT as defined by ANSI C78.377-2011. Products with a CCT of 5000K-6500K are hot targeted to $T_c = 85^\circ\text{C}$.
- CRI values are typical for Decor Series Ultra and Decor Series Class A products. CRI values are minimums for all other products. Minimum R9 value for 80 CRI products is 0, the minimum R9 values for 90 CRI products is 50, the minimum R9 values for 97 CRI products is 93. Bridgelux maintains a ± 3 tolerance on R9 values.
- Drive current is referred to as nominal drive current.
- Products tested under pulsed condition (10ms pulse width) at nominal test current where T_j (junction temperature) - T_c (case temperature) = 25°C .
- Typical performance values are provided as a reference only and are not a guarantee of performance.
- Bridgelux maintains a $\pm 7\%$ tolerance on flux measurements.
- Minimum flux values at the nominal test current are guaranteed by 100% test.
- Nominal CCT is defined by the Lighting Research Center's Class A definition. The center of the Class A color bin is on the corresponding isothermal line.
- GAI value is 80. To help ensure optimal fixture level performance, GAI is measured at the fixture level, on axis, at a case temperature of 70°C . GAI may vary depending on fixture design and performance.

Table 2: Selection Guide, Stabilized DC Performance ($T_c = 70^\circ\text{C}$)^{7,8}

Part Number	Nominal CCT ¹ (K)	GAI ²	CRI ³	Nominal Drive Current ⁴ (mA)	Typical DC Flux ^{5,6} $T_c = 70^\circ\text{C}$ (lm)	Minimum DC Flux ^{6,9} $T_c = 70^\circ\text{C}$ (lm)	Typical V_f (V)	Typical Power (W)	Typical Efficacy (lm/W)
BXRE-30A1001-B-73	3000	80	93	270	1009	888	34.3	9.3	109
BXRE-30A1001-C-73	3000	80	93	360	1346	1184	34.3	12.3	109
BXRE-35A1001-B-73	3500	80	93	270	1093	962	34.3	9.3	118
BXRE-35A1001-C-73	3500	80	93	360	1457	1282	34.3	12.3	118

Notes for Table 2:

- Nominal CCT is defined by the Lighting Research Center's Class A definition. The center of the Class A color bin is on the corresponding isothermal line.
- To help ensure optimal fixture level performance, GAI is measured at the fixture level, on axis, at a case temperature of 70°C . GAI may vary depending on fixture design and performance.
- All CRI values are measured at $T_j = T_c = 25^\circ\text{C}$. CRI Values are specified as typical.
- Drive current is referred to as nominal drive current.
- Typical performance values are provided as a reference only and are not a guarantee of performance.
- Bridgelux maintains a $\pm 7\%$ tolerance on flux measurements.
- Typical stabilized DC performance values are provided as reference only and are not a guarantee of performance.
- Typical performance is estimated based on operation under DC (direct current) with LED array mounted onto a heat sink with thermal interface material and the case temperature maintained at specified temperature. Based on Bridgelux test setup, values may vary depending on the thermal design of the luminaire and/or the exposed environment to which the product is subjected.
- Minimum flux values at elevated temperatures are provided for reference only and are not guaranteed by 100% production testing. Based on Bridgelux test setup, values may vary depending on the thermal design of the luminaire and/or the exposed environment to which the product is subjected.

Product Selection Guide

Table 3: Selection Guide, Stabilized DC Performance ($T_c = 85^\circ\text{C}$) ^{4,5}

Part Number	Nominal CCT ¹ (K)	CRI ²	Nominal Drive Current ³ (mA)	Typical DC Flux ^{4,5} $T_c = 85^\circ\text{C}$ (lm)	Minimum DC Flux ⁶ $T_c = 85^\circ\text{C}$ (lm)	Typical V_f (V)	Typical Power (W)	Typical Efficacy (lm/W)
BXRE-20B1000-B-73	2000	65	270	1203	1059	33.8	9.1	132
BXRE-27E1000-B-7X	2700	80	270	1214	1068	33.8	9.1	133
BXRE-27E1000-C-7X	2700	80	360	1617	1423	33.8	12.2	133
BXRE-27G1000-B-7X	2700	90	270	1011	890	33.8	9.1	111
BXRE-27G1000-C-7X	2700	90	360	1348	1186	33.8	12.2	111
BXRE-27H1000-B-7X	2700	97	270	885	778	33.8	9.1	97
BXRE-30E1000-B-7X	3000	80	270	1276	1123	33.8	9.1	140
BXRE-30E1000-C-7X	3000	80	360	1701	1497	33.8	12.2	140
BXRE-30G1000-B-7X	3000	90	270	1059	932	33.8	9.1	116
BXRE-30G1000-C-7X	3000	90	360	1412	1243	33.8	12.2	116
BXRE-30G100C-B-73	3000	90	270	986	868	33.8	9.1	108
BXRE-30G100C-C-73	3000	90	360	1316	1158	33.8	12.2	108
BXRE-30A1001-B-73 ^{7,8}	3000	93	270	986	868	33.8	9.1	108
BXRE-30A1001-C-73 ^{7,8}	3000	93	360	1316	1158	33.8	12.2	108
BXRE-30H1000-B-7X	3000	97	270	944	831	33.8	9.1	103
BXRE-35E1000-B-7X	3500	80	270	1302	1146	33.8	9.1	143
BXRE-35E1000-C-7X	3500	80	360	1735	1527	33.8	12.2	142
BXRE-35G1000-B-7X	3500	90	270	1087	957	33.8	9.1	119
BXRE-35G1000-C-7X	3500	90	360	1449	1275	33.8	12.2	119
BXRE-35A1001-B-73 ^{7,8}	3500	93	270	1046	921	33.8	9.1	115
BXRE-35A1001-C-73 ^{7,8}	3500	93	360	1395	1228	33.8	12.2	115
BXRE-40E1000-B-7X	4000	80	270	1315	1157	33.8	9.1	144
BXRE-40E1000-C-7X	4000	80	360	1752	1542	33.8	12.2	144
BXRE-40G1000-B-7X	4000	90	270	1125	990	33.8	9.1	123
BXRE-40G1000-C-7X	4000	90	360	1499	1320	33.8	12.2	123
BXRE-50C1001-B-7X	5000	70	270	1441	1268	33.8	9.1	158
BXRE-50C1001-C-7X	5000	70	360	1921	1690	33.8	12.2	158
BXRE-50E1001-B-7X	5000	80	270	1355	1192	33.8	9.1	148
BXRE-50E1001-C-7X	5000	80	360	1805	1589	33.8	12.2	148
BXRE-50G1001-B-7X	5000	90	270	1153	1015	33.8	9.1	126
BXRE-50G1001-C-7X	5000	90	360	1537	1352	33.8	12.2	126
BXRE-57C1001-B-7X	5700	70	270	1390	1224	33.8	9.1	152

Notes for Table 3:

- Nominal CCT as defined by ANSI C78.377-2011. Products with a CCT of 5000K-6500K are hot targeted to $T_c = 85^\circ\text{C}$.
- All CRI values are measured at $T_c = T_a = 25^\circ\text{C}$. CRI values are typical for Decor Series Ultra and Decor Series Class A products. CRI values are minimums for all other products. Minimum R_g value for 80 CRI products is 0, the minimum R_g values for 90 CRI products is 50, the minimum R_g values for 97 CRI products is 93. Bridgelux maintains a ± 3 tolerance on R_g values.
- Drive current is referred to as nominal drive current.
- Typical stabilized DC performance values are provided as reference only and are not a guarantee of performance.
- Typical performance is estimated based on operation under DC (direct current) with LED array mounted onto a heat sink with thermal interface material and the case temperature maintained at 85°C . Based on Bridgelux test setup, values may vary depending on the thermal design of the luminaire and/or the exposed environment to which the product is subjected.
- Minimum flux values at elevated temperatures are provided for reference only and are not guaranteed by 100% production testing. Based on Bridgelux test setup, values may vary depending on the thermal design of the luminaire and/or the exposed environment to which the product is subjected.
- Nominal CCT is defined by the Lighting Research Center's Class A definition. The center of the Class A color bin is on the corresponding isothermal line.
- GAI value is 80. To help ensure optimal fixture level performance, GAI is measured at the fixture level, on axis, at a case temperature of 70°C . GAI may vary depending on fixture design and performance.

Product Selection Guide

Table 3: Selection Guide, Stabilized DC Performance ($T_c = 85^\circ\text{C}$)^{4,5}

Part Number	Nominal CCT ¹ (K)	CRI ²	Nominal Drive Current ³ (mA)	Typical DC Flux ^{4,5} $T_c = 85^\circ\text{C}$ (lm)	Minimum DC Flux ⁶ $T_c = 85^\circ\text{C}$ (lm)	Typical V_f (V)	Typical Power (W)	Typical Efficacy (lm/W)
BXRE-57C1001-C-7X	5700	70	360	1853	1631	33.8	12.2	152
BXRE-57E1001-B-7X	5700	80	270	1378	1213	33.8	9.1	151
BXRE-57E1001-C-7X	5700	80	360	1836	1616	33.8	12.2	151
BXRE-65C1001-B-7X	6500	70	270	1416	1246	33.8	9.1	155
BXRE-65C1001-C-7X	6500	70	360	1887	1661	33.8	12.2	155
BXRE-65E1001-B-7X	6500	80	270	1403	1235	33.8	9.1	154
BXRE-65E1001-C-7X	6500	80	360	1870	1646	33.8	12.2	154

Notes for Table 3:

- Nominal CCT as defined by ANSI C78.377-2011. Products with a CCT of 5000K-6500K are hot targeted to $T_c = 85^\circ\text{C}$.
- All CRI values are measured at $T_s = T_c = 25^\circ\text{C}$. CRI values are typical for Decor Series Ultra and Decor Series Class A products. CRI values are minimums for all other products. Minimum Rg value for 80 CRI products is 0, the minimum Rg values for 90 CRI products is 50, the minimum Rg values for 97 CRI products is 93. Bridgelux maintains a ± 3 tolerance on Rg values.
- Drive current is referred to as nominal drive current.
- Typical stabilized DC performance values are provided as reference only and are not a guarantee of performance.
- Typical performance is estimated based on operation under DC (direct current) with LED array mounted onto a heat sink with thermal interface material and the case temperature maintained at 85°C . Based on Bridgelux test setup, values may vary depending on the thermal design of the luminaire and/or the exposed environment to which the product is subjected.
- Minimum flux values at elevated temperatures are provided for reference only and are not guaranteed by 100% production testing. Based on Bridgelux test setup, values may vary depending on the thermal design of the luminaire and/or the exposed environment to which the product is subjected.
- Nominal CCT is defined by the Lighting Research Center's Class A definition. The center of the Class A color bin is on the corresponding isothermal line.
- GAI value is 80. To help ensure optimal fixture level performance, GAI is measured at the fixture level, on axis, at a case temperature of 70°C . GAI may vary depending on fixture design and performance.

Performance at Commonly Used Drive Currents

V Series LED arrays are tested to the specifications shown using the nominal drive currents in Table 1. V Series LED Arrays may also be driven at other drive currents dependent on specific application design requirements. The performance at any drive current can be derived from the current vs. voltage characteristics shown in Figures 1 & 2 and the flux vs. current characteristics shown in Figures 3 & 4. The performance at commonly used drive currents is summarized in Table 4.

Table 4: Product Performance at Commonly Used Drive Currents

Part Number	CRI	Drive Current ¹ (mA)	Typical V_f $T_c = 25^\circ\text{C}$ (V)	Typical Power $T_c = 25^\circ\text{C}$ (W)	Typical Flux ² $T_c = 25^\circ\text{C}$ (lm)	Typical DC Flux ³ $T_c = 85^\circ\text{C}$ (lm)	Typical Efficacy $T_c = 25^\circ\text{C}$ (lm/W)
BXRE-20B1001-B-73	65	135	33.2	4.5	712	640	159
		180	34.0	6.1	934	838	153
		270	34.8	9.4	1337	1203	142
		405	35.6	14.4	1961	1745	136
		540	36.1	19.5	2513	2224	129
BXRE-27E1000-B-7X	80	135	33.2	4.5	719	646	160
		180	34.0	6.1	942	845	154
		270	34.8	9.4	1348	1214	144
		405	35.6	14.4	1978	1760	137
		540	36.1	19.5	2534	2243	130
BXRE-27E1000-C-7X	80	180	33.2	6.0	955	853	160
		240	34.0	8.2	1252	1112	153
		360	34.8	12.5	1797	1617	143
		540	35.6	19.2	2617	2273	136
		720	36.1	26.0	3343	2861	128
BXRE-27G1000-B-7X	90	135	33.2	4.5	599	538	134
		180	34.0	6.1	785	704	128
		270	34.8	9.4	1124	1011	120
		405	35.6	14.4	1648	1466	114
		540	36.1	19.5	2112	1869	108
BXRE-27G1000-C-7X	90	180	33.2	6.0	796	710	133
		240	34.0	8.2	1043	927	128
		360	34.8	12.5	1498	1348	120
		540	35.6	19.2	2181	1894	113
		720	36.1	26.0	2786	2385	107
BXRE-27H1000-B-7X	97	135	33.2	4.5	524	471	117
		180	34.0	6.1	687	616	112
		270	34.8	9.4	983	885	105
		405	35.6	14.4	1442	1283	100
		540	36.1	19.5	1847	1635	95
BXRE-30E1000-B-7X	80	135	33.2	4.5	755	679	168
		180	34.0	6.1	990	888	162
		270	34.8	9.4	1418	1276	151
		405	35.6	14.4	2080	1850	144
		540	36.1	19.5	2664	2358	137
BXRE-30E1000-C-7X	80	180	33.2	6.0	1005	897	168
		240	34.0	8.2	1316	1169	161
		360	34.8	12.5	1890	1701	151
		540	35.6	19.2	2752	2391	143
		720	36.1	26.0	3516	3009	135

Notes for Table 4:

1. Alternate drive currents are provided for reference only and are not a guarantee of performance.
2. Bridgelux maintains a $\pm 7\%$ tolerance on flux measurements.
3. Typical stabilized DC performance values are provided as reference only and are not a guarantee of performance.

Performance at Commonly Used Drive Currents

Table 4: Product Performance at Commonly Used Drive Currents (Continued)

Part Number	CRI	Drive Current ¹ (mA)	Typical V_f $T_c = 25^\circ\text{C}$ (V)	Typical Power $T_c = 25^\circ\text{C}$ (W)	Typical Flux ² $T_c = 25^\circ\text{C}$ (lm)	Typical DC Flux ³ $T_c = 85^\circ\text{C}$ (lm)	Typical Efficacy $T_c = 25^\circ\text{C}$ (lm/W)
BXRE-30G1000-B-7X	90	135	33.2	4.5	627	564	140
		180	34.0	6.1	822	738	134
		270	34.8	9.4	1177	1059	125
		405	35.6	14.4	1727	1536	120
		540	36.1	19.5	2212	1958	113
BXRE-30G1000-C-7X	90	180	33.2	6.0	834	744	140
		240	34.0	8.2	1093	971	134
		360	34.8	12.5	1569	1412	125
		540	35.6	19.2	2285	1985	119
		720	36.1	26.0	2918	2498	112
BXRE-30G100C-B-73	90	135	33.2	4.5	584	525	130
		180	34.0	6.1	766	687	125
		270	34.8	9.4	1096	986	117
		405	35.6	14.4	1608	1430	111
		540	36.1	19.5	2060	1823	106
BXRE-30G100C-C-73	90	180	33.2	6.0	777	694	130
		240	34.0	8.2	1018	905	125
		360	34.8	12.5	1462	1316	117
		540	35.6	19.2	2129	1849	111
		720	36.1	26.0	2719	2328	104
BXRE-30A1001-B-73	93	135	33.2	4.5	584	525	130
		180	34.0	6.1	766	687	125
		270	34.8	9.4	1096	986	117
		405	35.6	14.4	1608	1430	111
		540	36.1	19.5	2060	1823	106
BXRE-30A1001-C-73	93	180	33.2	6.0	777	694	130
		240	34.0	8.2	1018	905	125
		360	34.8	12.5	1462	1316	117
		540	35.6	19.2	2129	1849	111
		720	36.1	26.0	2719	2328	104
BXRE-30H1000-B-7X	97	135	33.2	4.5	559	502	125
		180	34.0	6.1	733	657	120
		270	34.8	9.4	1049	944	112
		405	35.6	14.4	1539	1369	107
		540	36.1	19.5	1972	1745	101
BXRE-35E1000-B-7X	80	135	33.2	4.5	771	693	172
		180	34.0	6.1	1011	907	165
		270	34.8	9.4	1447	1302	154
		405	35.6	14.4	2122	1888	147
		540	36.1	19.5	2719	2407	139
BXRE-35E1000-C-7X	80	180	33.2	6.0	1025	915	171
		240	34.0	8.2	1343	1193	165
		360	34.8	12.5	1928	1735	154
		540	35.6	19.2	2808	2439	146
		720	36.1	26.0	3586	3070	138

Notes for Table 4:

1. Alternate drive currents are provided for reference only and are not a guarantee of performance.
2. Bridgelux maintains a $\pm 7\%$ tolerance on flux measurements.
3. Typical stabilized DC performance values are provided as reference only and are not a guarantee of performance.

Performance at Commonly Used Drive Currents

Table 4: Product Performance at Commonly Used Drive Currents (Continued)

Part Number	CRI	Drive Current ¹ (mA)	Typical V _f T _c = 25°C (V)	Typical Power T _c = 25°C (W)	Typical Flux ² T _c = 25°C (lm)	Typical DC Flux ³ T _c = 85°C (lm)	Typical Efficacy T _c = 25°C (lm/W)
BXRE-35G1000-B-7X	90	135	33.2	4.5	644	578	144
		180	34.0	6.1	844	757	138
		270	34.8	9.4	1208	1087	129
		405	35.6	14.4	1772	1576	123
		540	36.1	19.5	2270	2009	116
BXRE-35G1000-C-7X	90	180	33.2	6.0	856	764	143
		240	34.0	8.2	1121	996	137
		360	34.8	12.5	1610	1449	129
		540	35.6	19.2	2344	2037	122
		720	36.1	26.0	2995	2563	115
BXRE-35A1001-B-73	93	135	33.2	4.5	619	557	138
		180	34.0	6.1	812	728	133
		270	34.8	9.4	1162	1046	124
		405	35.6	14.4	1705	1517	118
		540	36.1	19.5	2185	1934	112
BXRE-35A1001-C-73	93	180	33.2	6.0	824	735	138
		240	34.0	8.2	1080	959	132
		360	34.8	12.5	1550	1395	124
		540	35.6	19.2	2257	1961	117
		720	36.1	26.0	2883	2468	111
BXRE-40E1000-B-7X	80	135	33.2	4.5	778	700	174
		180	34.0	6.1	1021	915	167
		270	34.8	9.4	1461	1315	155
		405	35.6	14.4	2143	1906	148
		540	36.1	19.5	2745	2430	141
BXRE-40E1000-C-7X	80	180	33.2	6.0	1035	924	173
		240	34.0	8.2	1356	1205	166
		360	34.8	12.5	1947	1752	155
		540	35.6	19.2	2835	2463	147
		720	36.1	26.0	3621	3100	139
BXRE-40G1000-B-7X	90	135	33.2	4.5	666	599	149
		180	34.0	6.1	873	783	143
		270	34.8	9.4	1250	1125	133
		405	35.6	14.4	1834	1631	127
		540	36.1	19.5	2349	2079	120
BXRE-40G1000-C-7X	90	180	33.2	6.0	886	790	148
		240	34.0	8.2	1160	1031	142
		360	34.8	12.5	1666	1499	133
		540	35.6	19.2	2426	2108	126
		720	36.1	26.0	3099	2653	119
BXRE-50C1001-B-7X	70	135	33.2	4.5	853	767	190
		180	34.0	6.1	1119	1003	183
		270	34.8	9.4	1601	1441	170
		405	35.6	14.4	2349	2090	163
		540	36.1	19.5	3009	2664	154

Notes for Table 4:

1. Alternate drive currents are provided for reference only and are not a guarantee of performance.
2. Bridgelux maintains a ± 7% tolerance on flux measurements.
3. Typical stabilized DC performance values are provided as reference only and are not a guarantee of performance.

Performance at Commonly Used Drive Currents

Table 4: Product Performance at Commonly Used Drive Currents (Continued)

Part Number	CRI	Drive Current ¹ (mA)	Typical V _f T _c = 25°C (V)	Typical Power T _c = 25°C (W)	Typical Flux ² T _c = 25°C (lm)	Typical DC Flux ³ T _c = 85°C (lm)	Typical Efficacy T _c = 25°C (lm/W)
BXRE-50C1001-C-7X	70	180	33.2	6.0	1135	1012	190
		240	34.0	8.2	1486	1321	182
		360	34.8	12.5	2134	1921	170
		540	35.6	19.2	3108	2700	161
		720	36.1	26.0	3970	3398	153
BXRE-50E1001-B-7X	80	135	33.2	4.5	802	721	179
		180	34.0	6.1	1052	943	172
		270	34.8	9.4	1505	1355	160
		405	35.6	14.4	2208	1964	153
		540	36.1	19.5	2829	2504	145
BXRE-50E1001-C-7X	80	180	33.2	6.0	1067	952	178
		240	34.0	8.2	1397	1241	171
		360	34.8	12.5	2006	1805	160
		540	35.6	19.2	2921	2538	152
		720	36.1	26.0	3731	3194	143
BXRE-50G1001-B-7X	90	135	33.2	4.5	683	613	152
		180	34.0	6.1	895	803	146
		270	34.8	9.4	1281	1153	136
		405	35.6	14.4	1879	1672	130
		540	36.1	19.5	2408	2131	123
BXRE-50G1001-C-7X	90	180	33.2	6.0	908	810	152
		240	34.0	8.2	1189	1056	146
		360	34.8	12.5	1707	1537	136
		540	35.6	19.2	2486	2160	129
		720	36.1	26.0	3176	2718	122
BXRE-57C1001-B-7X	70	135	33.2	4.5	823	740	184
		180	34.0	6.1	1079	968	176
		270	34.8	9.4	1545	1390	164
		405	35.6	14.4	2267	2016	157
		540	36.1	19.5	2904	2570	149
BXRE-57C1001-C-7X	70	180	33.2	6.0	1095	977	183
		240	34.0	8.2	1434	1274	176
		360	34.8	12.5	2059	1853	164
		540	35.6	19.2	2998	2605	156
		720	36.1	26.0	3830	3279	147
BXRE-57E1001-B-7X	80	135	33.2	4.5	816	733	182
		180	34.0	6.1	1070	959	175
		270	34.8	9.4	1531	1378	163
		405	35.6	14.4	2246	1998	156
		540	36.1	19.5	2877	2547	147
BXRE-57E1001-C-7X	80	180	33.2	6.0	1085	968	181
		240	34.0	8.2	1421	1263	174
		360	34.8	12.5	2040	1836	163
		540	35.6	19.2	2971	2581	154
		720	36.1	26.0	3795	3249	146

Notes for Table 4:

1. Alternate drive currents are provided for reference only and are not a guarantee of performance.
2. Bridgelux maintains a ± 7% tolerance on flux measurements.
3. Typical stabilized DC performance values are provided as reference only and are not a guarantee of performance.

Performance at Commonly Used Drive Currents

Table 4: Product Performance at Commonly Used Drive Currents (Continued)

Part Number	CRI	Drive Current ¹ (mA)	Typical V_f $T_c = 25^\circ\text{C}$ (V)	Typical Power $T_c = 25^\circ\text{C}$ (W)	Typical Flux ² $T_c = 25^\circ\text{C}$ (lm)	Typical DC Flux ³ $T_c = 85^\circ\text{C}$ (lm)	Typical Efficacy $T_c = 25^\circ\text{C}$ (lm/W)
BXRE-65C1001-B-7X	70	135	33.2	4.5	838	753	187
		180	34.0	6.1	1099	986	180
		270	34.8	9.4	1573	1416	167
		405	35.6	14.4	2308	2053	160
		540	36.1	19.5	2957	2617	151
BXRE-65C1001-C-7X	70	180	33.2	6.0	1115	995	186
		240	34.0	8.2	1460	1297	179
		360	34.8	12.5	2097	1887	167
		540	35.6	19.2	3053	2652	159
BXRE-65E1001-B-7X	80	135	33.2	4.5	831	747	185
		180	34.0	6.1	1089	977	178
		270	34.8	9.4	1559	1403	166
		405	35.6	14.4	2287	2035	158
		540	36.1	19.5	2930	2593	150
BXRE-65E1001-C-7X	80	180	33.2	6.0	1105	986	185
		240	34.0	8.2	1447	1286	177
		360	34.8	12.5	2078	1870	166
		540	35.6	19.2	3026	2629	157
		720	36.1	26.0	3865	3309	149

Notes for Table 4:

1. Alternate drive currents are provided for reference only and are not a guarantee of performance.
2. Bridgelux maintains a $\pm 7\%$ tolerance on flux measurements.
3. Typical stabilized DC performance values are provided as reference only and are not a guarantee of performance.

Electrical Characteristics

Table 5: Electrical Characteristics

Part Number	Drive Current (mA)	Forward Voltage Pulsed, $T_c = 25^\circ\text{C}$ (V) ^{1, 2, 3, 8}			Typical Coefficient of Forward Voltage ⁴ $\Delta V_f / \Delta T_c$ (mV/ $^\circ\text{C}$)	Typical Thermal Resistance Junction to Case ^{5,6} R_{j-c} ($^\circ\text{C}/\text{W}$)	Driver Selection Voltages ⁷ (V)	
		Minimum	Typical	Maximum			V_f Min. Hot $T_c = 105^\circ\text{C}$ (V)	V_f Max. Cold $T_c = -40^\circ\text{C}$ (V)
BXRE-xxx100x-B-7x	270	32.2	34.8	37.4	-16.1	0.49	30.9	38.5
	540	33.4	36.1	38.8	-16.1	0.56	32.1	39.9
BXRE-xxx100x-C-7x	360	32.2	34.8	37.4	-16.1	0.37	30.9	38.5
	720	33.4	36.1	38.8	-16.1	0.45	32.1	39.9

Notes for Table 5:

- Parts are tested in pulsed conditions. $T_c = 25^\circ\text{C}$. Pulse width is 10ms.
- Voltage minimum and maximum are provided for reference only and are not a guarantee of performance.
- Bridgelux maintains a tester tolerance of $\pm 0.10\text{V}$ on forward voltage measurements.
- Typical coefficient of forward voltage tolerance is $\pm 0.1\text{mV}$ for nominal current.
- Thermal resistance values are based from test data of a 3000K 80 CRI product.
- Thermal resistance value was calculated using total electrical input power; optical power was not subtracted from input power. The thermal interface material used during testing is not included in the thermal resistance value.
- V_f min hot and max cold values are provided as reference only and are not guaranteed by test. These values are provided to aid in driver design and selection over the operating range of the product.
- This product has been designed and manufactured per IEC 62031:2014. This product has passed dielectric withstand voltage testing at 1160 V. The working voltage designated for the insulation is 80V d.c. The maximum allowable voltage across the array must be determined in the end product application.

Eye Safety

Table 6: Eye Safety Risk Group (RG) Classifications

Part Number	Drive Current ⁵ (mA)	CCT ¹⁻⁵			
		2700K/3000K	4000K ²	5000K ³	6500K ⁴
BXRE-xxx100x-B-7x	270	RG1	RG1	RG1	RG1
	405	RG1	RG1	RG1	RG2
	540	RG1	RG1	RG2	RG2
BXRE-xxx100x-C-7x	360	RG1	RG1	RG1	RG2
	540	RG1	RG1	RG2	RG2
	720	RG1	RG2	RG2	RG2

Notes for Table 6:

1. Eye safety classification for the use of Bridgelux V Series LED arrays is in accordance with specification IEC/TR 62778: Application of IEC 62471 for the assessment of blue light hazard to light sources and luminaires.
2. For products classified as RG2 at 4000K, $E_{thr} = 1847.5$ lx.
3. For products classified as RG2 at 5000K, $E_{thr} = 1315.8$ lx.
4. For products classified as RG2 at 6500K, $E_{thr} = 1124.5$ lx.
5. Please contact your Bridgelux sales representative for E_{thr} values at specific drive currents and CCTs not listed.

Absolute Maximum Ratings

Table 7: Maximum Ratings

Parameter	Maximum Rating	
LED Junction Temperature (T _j)	125°C	
Storage Temperature	-40°C to +105°C	
Operating Case Temperature ¹ (T _c)	105°C	
Soldering Temperature ²	300°C or lower for a maximum of 6 seconds	
	BXRE-xxx100x-B-7x	BXRE-xxx100x-C-7x
Maximum Drive Current ³	540mA	720mA
Maximum Peak Pulsed Drive Current ⁴	770mA	1030mA
Maximum Reverse Voltage ⁵	-60V	-60V

Notes for Table 7:

1. For IEC 62717 requirement, please consult your Bridgelux sales representative.
2. Refer to Bridgelux Application Note AN101: Handling and Assembly of Bridgelux V Series LED Arrays.
3. Arrays may be driven at higher currents however lumen maintenance may be reduced.
4. Bridgelux recommends a maximum duty cycle of 10% and pulse width of 20 ms when operating LED Arrays at maximum peak pulsed current specified. Maximum peak pulsed currents indicate values where LED Arrays can be driven without catastrophic failures.
5. Light emitting diodes are not designed to be driven in reverse voltage and will not produce light under this condition. Maximum rating provided for reference only.

Performance Curves

Figure 1: V10B Drive Current vs. Voltage

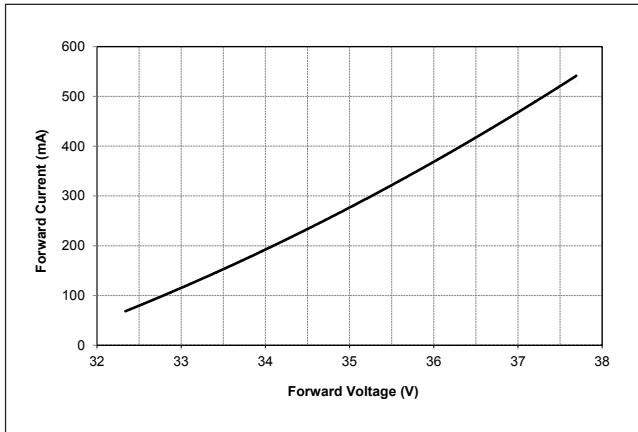

Figure 2: V10C Drive Current vs. Voltage

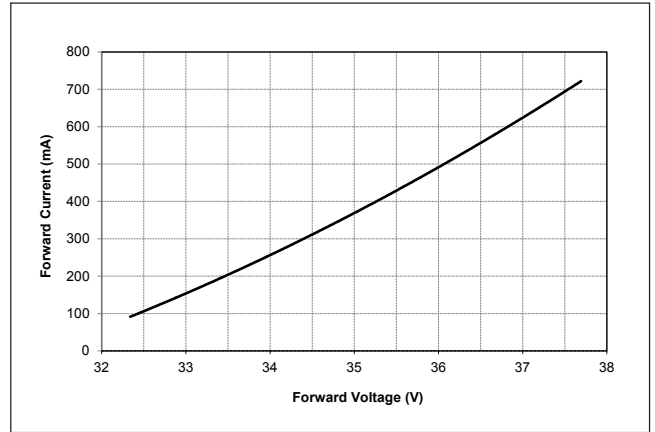

Figure 3: V10B Typical Relative Flux vs. Current

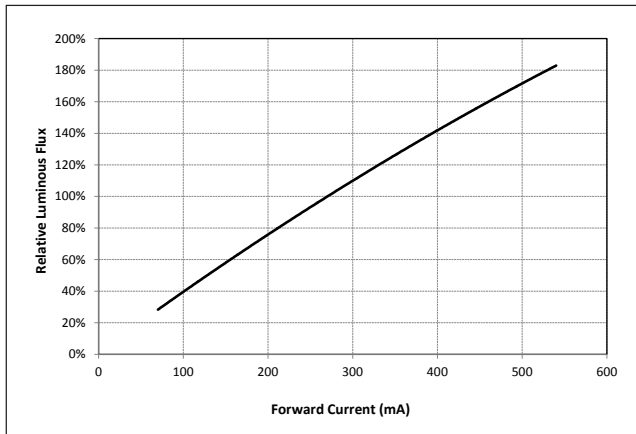
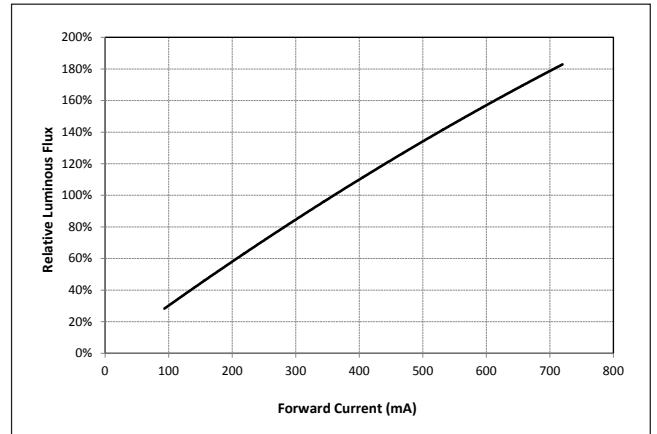

Figure 4: V10C Typical Relative Flux vs. Current



Notes for Figures 1-4:

1. Bridgelux does not recommend driving high power LEDs at low currents. Doing so may produce unpredictable results. Pulse width modulation (PWM) is recommended for dimming effects.
2. Products tested under pulsed condition (10ms pulse width) at nominal test current where T_j (junction temperature) = T_c (case temperature) = 25°C.

Performance Curves

Figure 5: Typical DC Flux vs. Case Temperature⁵

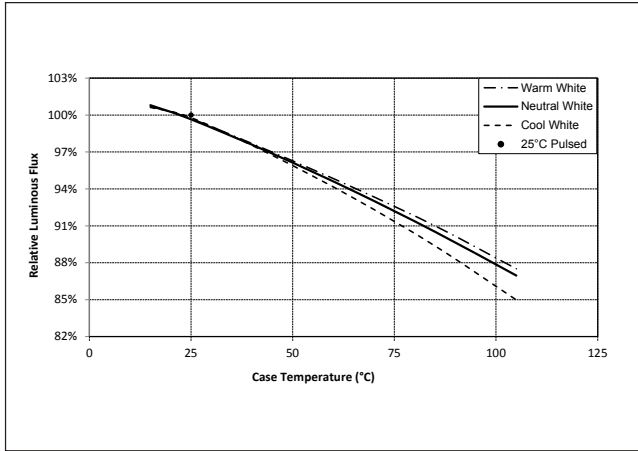

Figure 6: Typical DC ccy Shift vs. Case Temperature

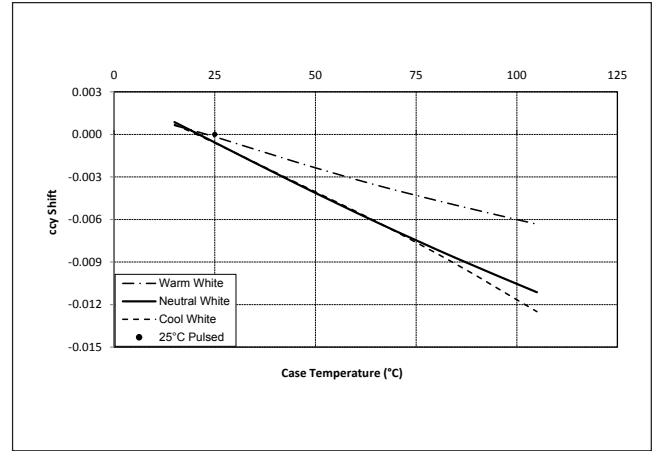
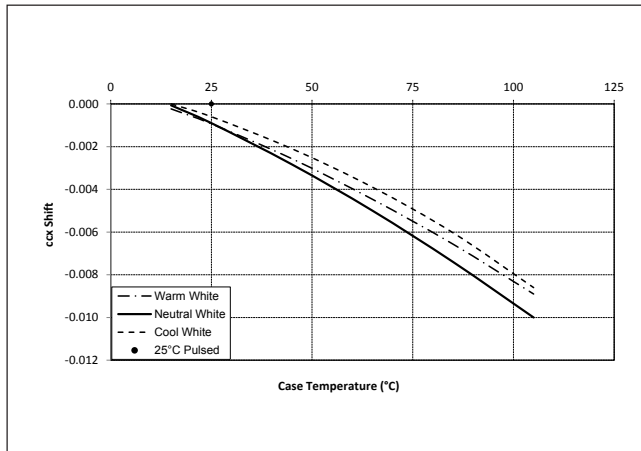

Figure 7: Typical DC ccx Shift vs. Case Temperature



Notes for Figures 5-7:

1. Characteristics shown for warm white based on 3000K and 80 CRI.
2. Characteristics shown for neutral white based on 4000K and 80 CRI.
3. Characteristics shown for cool white based on 5000K and 70 CRI.
4. Characteristics shown for warm white includes Decor Series Class A
5. For other color SKUs, the shift in color will vary. Please contact your Bridgelux Sales Representative for more information.

Performance Curves

Figure 8: 2000K, 65 CRI Color Shift vs. Case Temperature

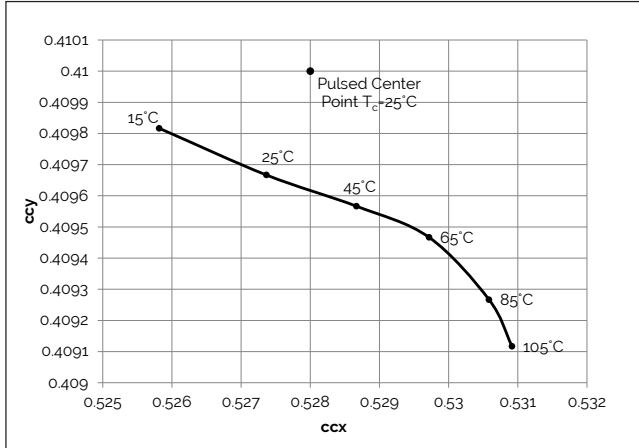

Figure 9: 3000K, 90 CRI Color Shift vs. Case Temperature^{1,3}

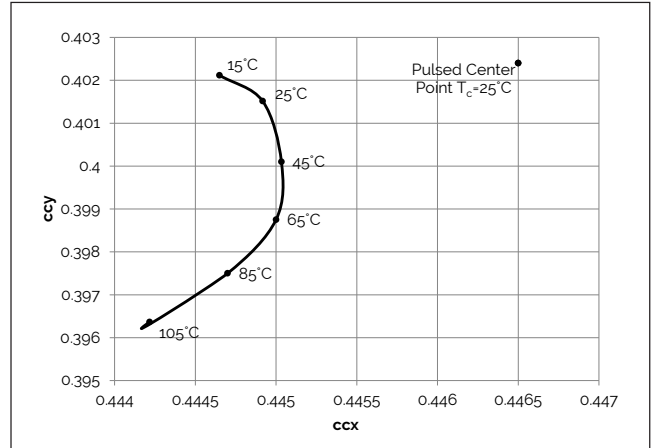

Figure 10: 2700K, 97 CRI Color Shift vs. Case Temperature¹

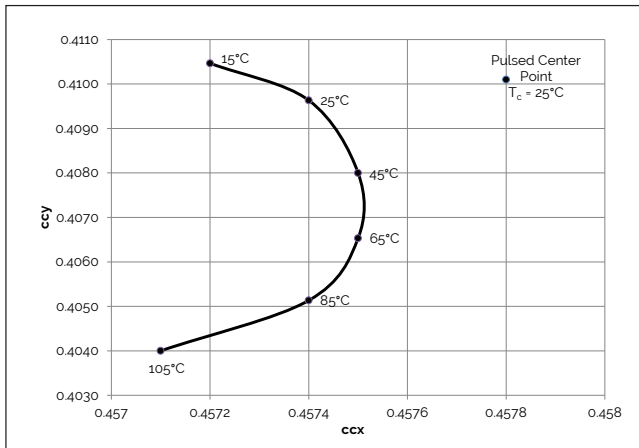

Figure 11: 3000K, 97 CRI Color Shift vs. Case Temperature¹

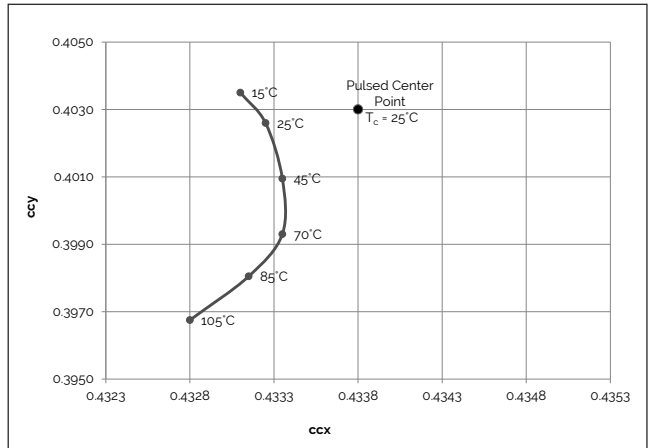

Figure 12: 3000K Class A Color Shift vs. Case Temperature¹

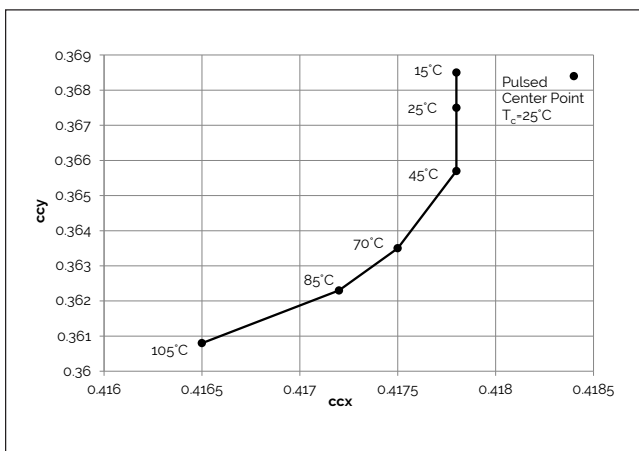
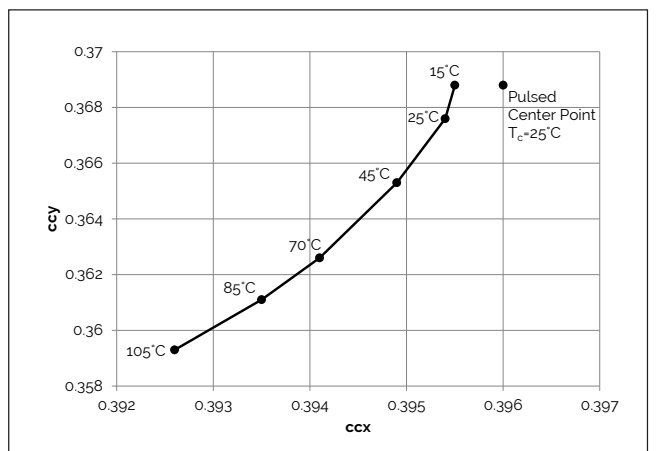

Figure 13: 3500K Class A Color Shift vs. Case Temperature¹



Note for Figures 8-13:

1. Measurements made under DC test conditions at the nominal drive current.
2. Typical color shift is shown with a tolerance of ± 0.002 .
3. Characteristics shown for Decor Series Showcase products, BXRE-30G100C-x-73

Typical Radiation Pattern

Figure 14: Typical Spatial Radiation Pattern

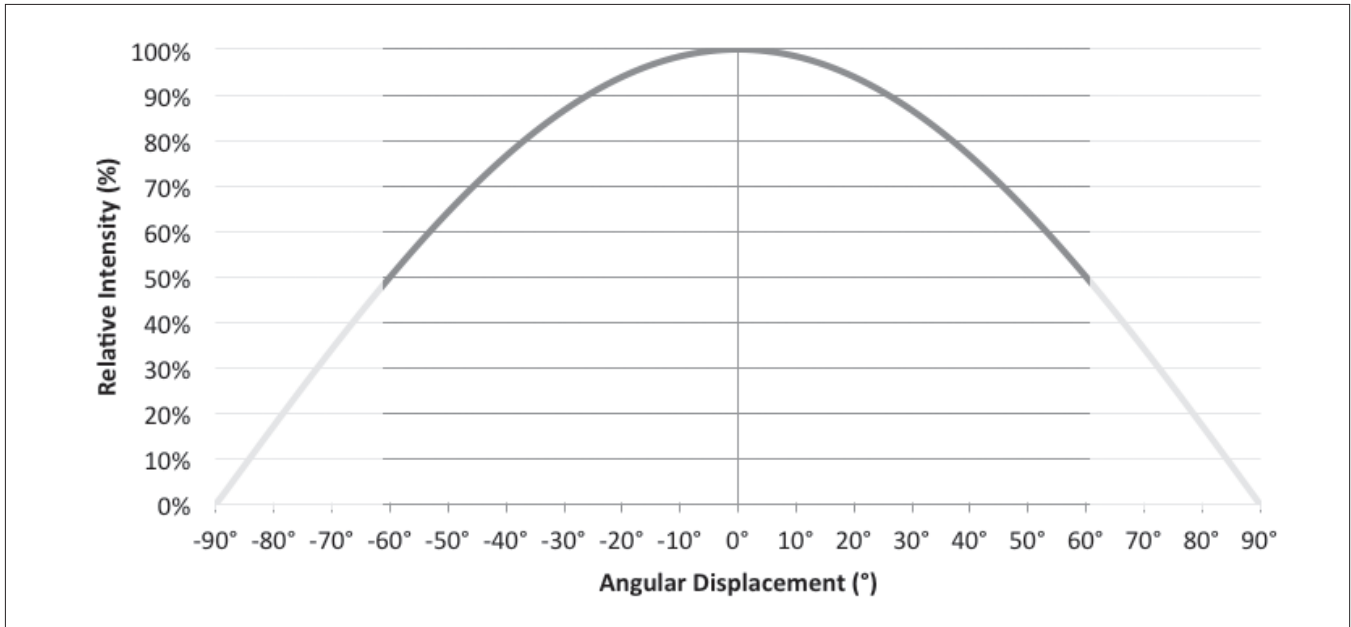

Note for Figure 14:

1. Typical viewing angle is 120°.
2. The viewing angle is defined as the off axis angle from the centerline where intensity is ½ of the peak value.

Figure 15: Typical Polar Radiation Pattern

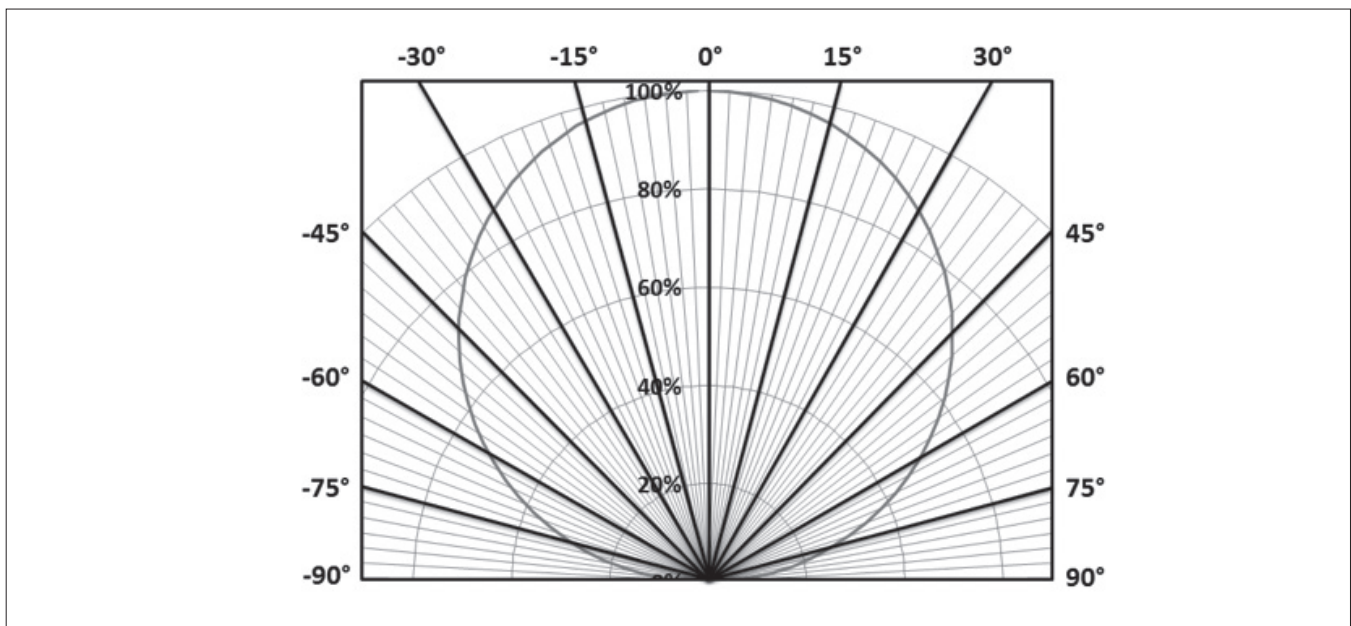

Typical Color Spectrum

Figure 16: Typical Color Spectrum

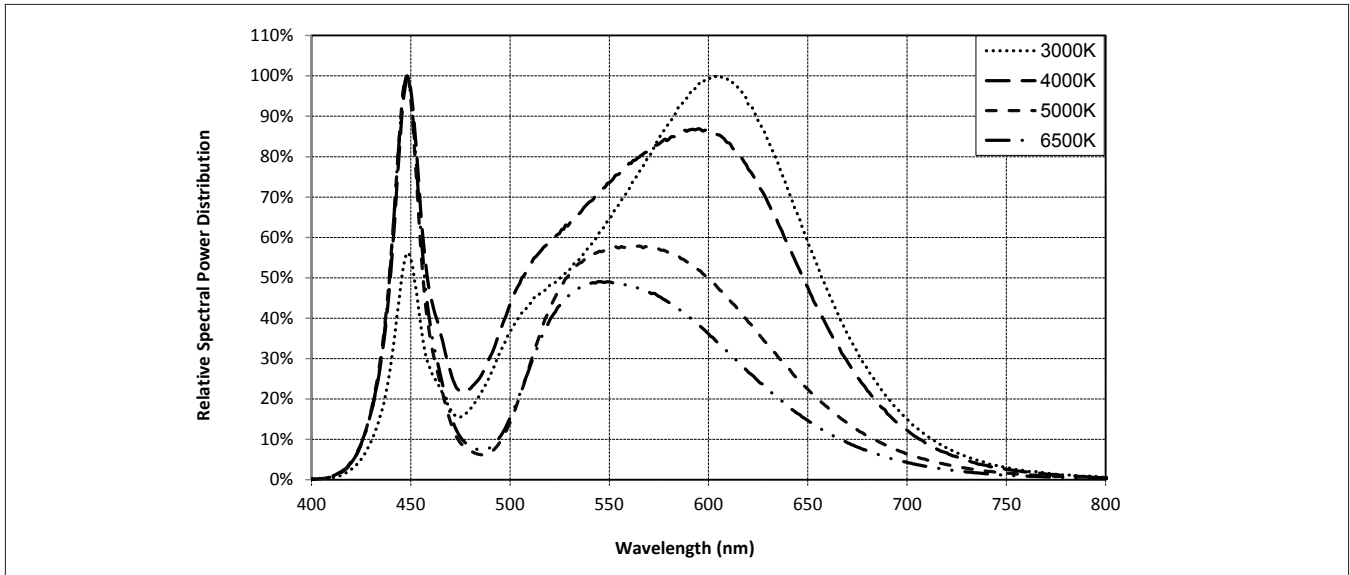

Note for Figure 16:

1. Color spectra measured at nominal current for $T_j = T_c = 25^\circ\text{C}$.
2. Color spectra shown is 3000K and 80 CRI.
3. Color spectra shown is 4000K and 80 CRI.
4. Color spectra shown is 5000K and 70 CRI.
4. Color spectra shown is 6500K and 70 CRI.

Figure 17: Typical Color Spectrum for Décor Series

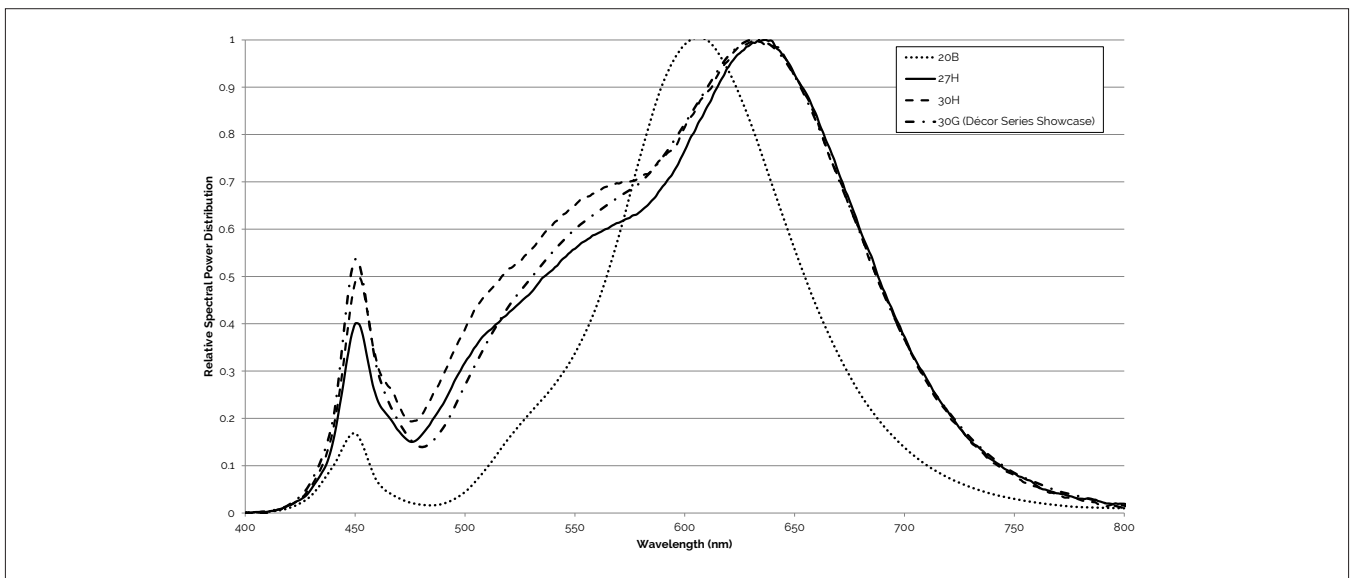

Note for Figure 17:

1. Color spectra measured at nominal current for $T_j = T_c = 25^\circ\text{C}$.

Mechanical Dimensions

Figure 18: Drawing for V10 LED Array

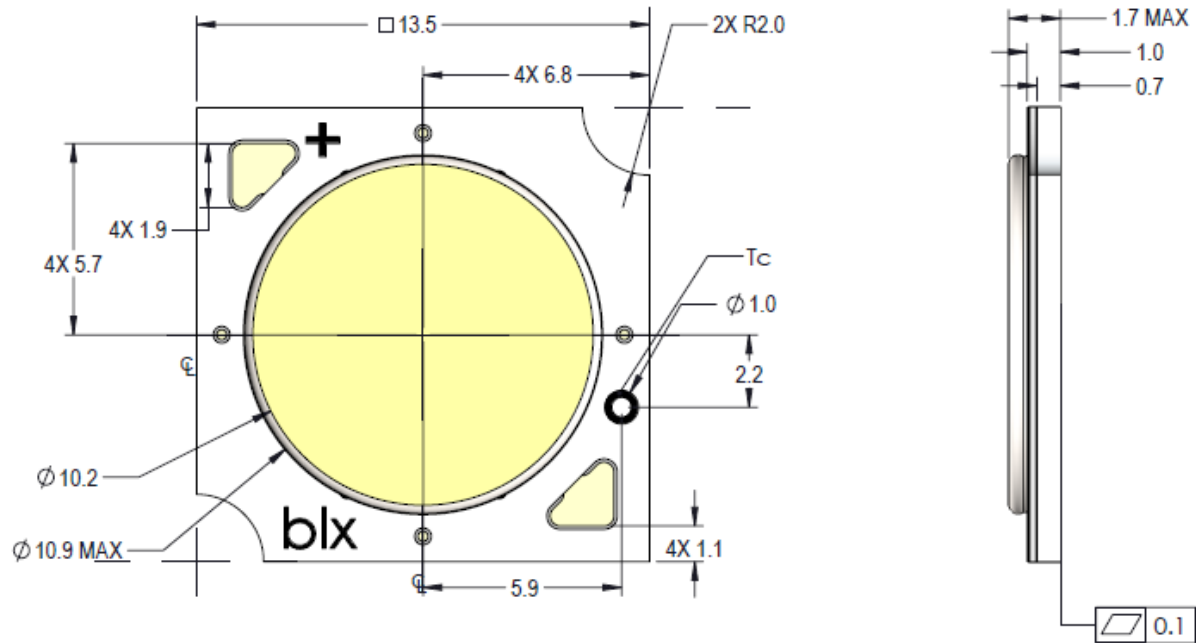

Notes for Figure 18:

1. Drawings are not to scale.
2. Drawing dimensions are in millimeters.
3. Unless otherwise specified, tolerances are ± 0.1 mm.
4. Solder pad labeled "+" denotes positive contact.
5. Refer to Application Notes AN101 for product handling, mounting and heat sink recommendations.
6. The optical center of the LED Array is nominally defined by the mechanical center of the array to a tolerance of ± 0.2 mm.
7. Bridgelux maintains a flatness of 0.10mm across the mounting surface of the array.

Color Binning Information

Figure 19: Warm and Neutral White Test Bins in xy Color Space

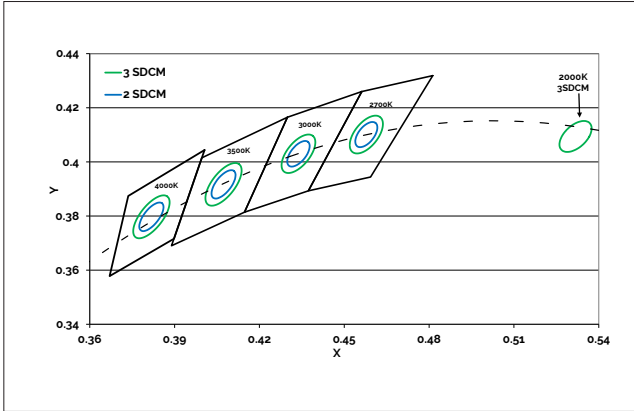

Note: Pulsed Test Conditions, $T_c = 25^\circ\text{C}$

Figure 20: Cool White Test Bins in xy Color Space

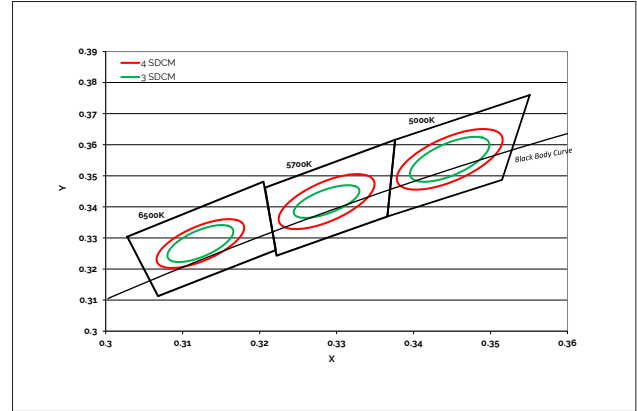

Note: Pulsed Test Conditions, $T_c = 25^\circ\text{C}$

Table 8: Warm and Neutral White xy Bin Coordinates and Associated Typical CCT

Bin Code	2000K	2700K	3000K ¹	3500K ¹	4000K ¹
ANSI Bin (for reference only)	-	(2580K - 2870K)	(2870K - 3220K)	(3220K - 3710K)	(3710K - 4260K)
73 (3 SDCM)	-	(2651K - 2794K)	(2968K - 3136K)	(3369K - 3586K)	(3851K - 4130K)
72 (2 SDCM)	-	(2674K - 2769K)	(2995K - 3107K)	(3404K - 3548K)	(3895K - 4081K)
Center Point (x,y)	(0.5280, 0.4100)	(0.4578, 0.4101)	(0.4338, 0.403) (0.4465, 0.4024) ²	(0.4073, 0.3917)	(0.3818, 0.3797)

Note for Table 8:

- Color Binning information excludes Décor Series Class A products. Please contact your Bridgelux Sales Representative for more information.
- Center Point for Décor Series Showcase.

Table 9: Cool White xy Bin Coordinates and Associated Typical CCT (product is hot targeted to $T_c = 85^\circ\text{C}$)

Bin Code	5000K	5700K	6500K
ANSI Bin (for reference only)	(4745K - 5311K)	(5312K - 6022K)	(6022K - 7042K)
74 (4 SDCM)	(4801K - 5282K)	(5481K - 5829K)	(6270K - 6765K)
73 (3 SDCM)	(4835K - 5215K)	(5490K - 5820K)	(6250K - 6745K)
Center Point (x,y)	(0.3447, 0.3553)	(0.3287, 0.3417)	(0.3123, 0.3282)

Packaging and Labeling

Figure 21: Drawing for V10 Packaging Tray

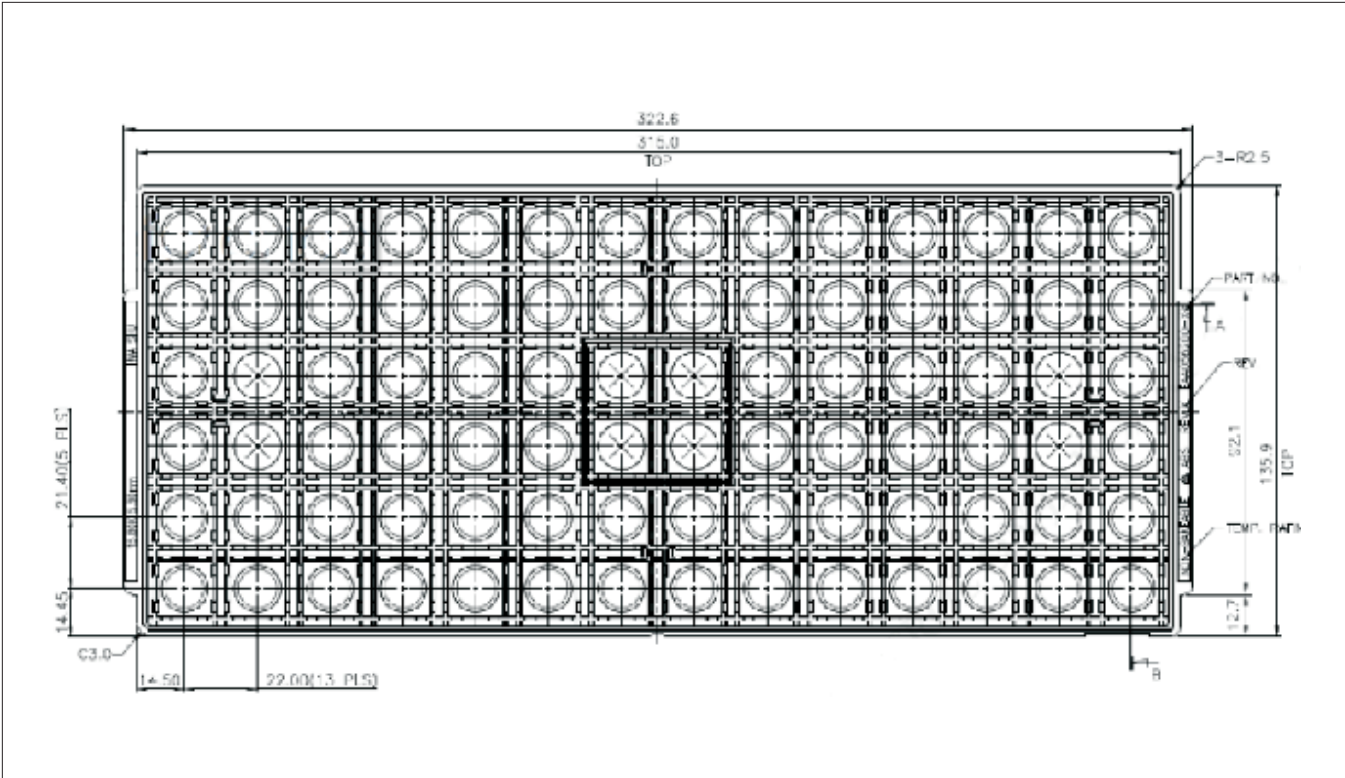

Notes for Figure 21:

1. Dimensions are in millimeters
2. Tolerances: XX = ± 0.25, XXX = ± 0.13, X'o' = ±0'30'
3. Trays are stackable without interference and will not stick together during unstacking operation

Packaging and Labeling

Figure 22: V Series Packaging and Labeling

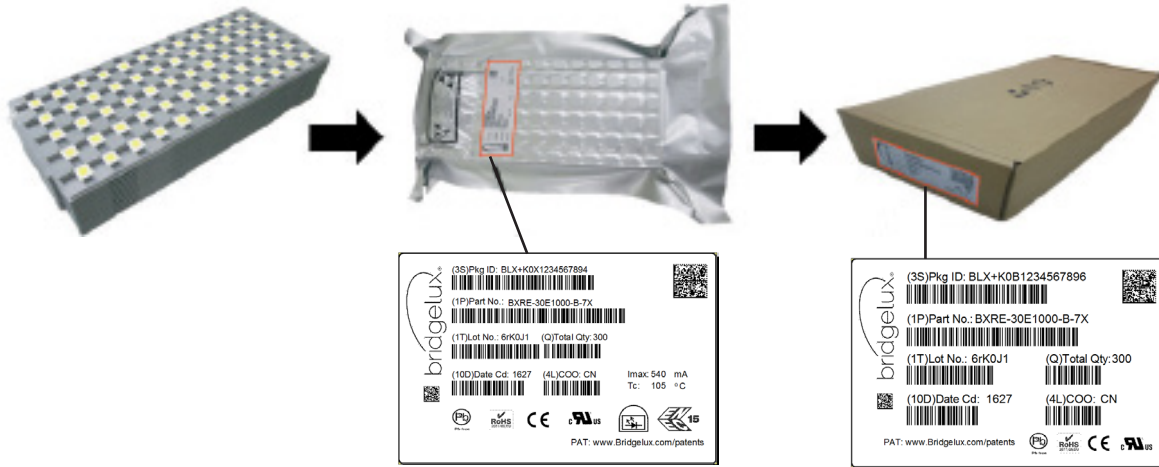

Notes for Figure 22:

1. Each tray holds 60 COB Arrays, 10 trays are stacked and one empty tray placed on top to cover the top tray.
2. Stacked trays are to contain only 1 part number and be vacuum sealed in an anti-static bag and placed in its own individual box.
3. Each bag and box is to be labeled as shown above.

Figure 23: Gen. 7 Product Labeling

Bridgelux COB arrays have laser markings on the back side of the substrate to help with product identification. In addition to the product identification markings, Bridgelux COB arrays also contain markings for internal Bridgelux manufacturing use only. The image below shows which markings are for customer use and which ones are for Bridgelux internal use only. The Bridgelux internal manufacturing markings are subject to change without notice, however these will not impact the form, function or performance of the COB array.



Design Resources

Application Notes

Bridgelux has developed a comprehensive set of application notes and design resources to assist customers in successfully designing with the V Series product family of LED array products. For all available application notes visit www.bridgelux.com.

Optical Source Models

Optical source models and ray set files are available for all Bridgelux products. For a list of available formats, visit www.bridgelux.com.

3D CAD Models

Three dimensional CAD models depicting the product outline of all Bridgelux V Series LED arrays are available in both IGS and STEP formats. Please contact your Bridgelux sales representative for assistance.

LM80

LM80 testing has been completed and the LM80 report is now available. Please contact your Bridgelux sales representative for LM-80 report.

Precautions

CAUTION: CHEMICAL EXPOSURE HAZARD

Exposure to some chemicals commonly used in luminaire manufacturing and assembly can cause damage to the LED array. Please consult Bridgelux Application Note AN101 for additional information.

CAUTION: RISK OF BURN

Do not touch the V Series LED array during operation. Allow the array to cool for a sufficient period of time before handling. The V Series LED array may reach elevated temperatures such that could burn skin when touched.

CAUTION

CONTACT WITH LIGHT EMITTING SURFACE (LES)

Avoid any contact with the LES. Do not touch the LES of the LED array or apply stress to the LES (yellow phosphor resin area). Contact may cause damage to the LED array.

Optics and reflectors must not be mounted in contact with the LES (yellow phosphor resin area).

Disclaimers

MINOR PRODUCT CHANGE POLICY

The rigorous qualification testing on products offered by Bridgelux provides performance assurance. Slight cosmetic changes that do not affect form, fit, or function may occur as Bridgelux continues product optimization.

STANDARD TEST CONDITIONS

Unless otherwise stated, array testing is performed at the nominal drive current.

About Bridgelux: We Build Light That Transforms

At Bridgelux, we help companies, industries and people experience the power and possibility of light. Since 2002, we've designed LED solutions that are high performing, energy efficient, cost effective and easy to integrate. Our focus is on light's impact on human behavior, delivering products that create better environments, experiences and returns—both experiential and financial. And our patented technology drives new platforms for commercial and industrial luminaires.

For more information about the company, please visit
bridgelux.com
twitter.com/Bridgelux
facebook.com/Bridgelux
youtube.com/user/Bridgelux
linkedin.com/company/bridgelux-inc-_2
WeChat ID: BridgeluxInChina



46430 Fremont Boulevard
Fremont, CA 94538
Tel (925) 583-8400
www.bridgelux.com

© 2016-2017 Bridgelux, Inc. All rights reserved 2016-2017. Product specifications are subject to change without notice. Bridgelux, the Bridgelux stylized logo design and Vero are registered trademarks, and Decor Series is a trademark of Bridgelux, Inc. All other trademarks are the property of their respective owners.

Bridgelux Gen 7 V10 Array Series Product Data Sheet DS100 Rev. H (6/2017)