

EMERGENCY LIGHTING DEVICES FOR LED APPLICATIONS



ELECTRONIC EMERGENCY LIGHTING DEVICES WITH IRON PHOSPHATE BATTERIES

For nominal operating periods of 1 hour or 3 hours

Emergency lighting systems spring to life any time normal mains lighting systems fail. Emergency lighting is designed to ensure that staff can safely leave any rooms and that there is sufficient lighting to illuminate rescue paths/routes as well as to avoid panic situations.

VS emergency lighting devices are designed for use with LED applications and can be operated as part of a combined system with electronic LED drivers.



Emergency Basic

Product features

- Designed for installation in LED luminaires for safety lighting for rescue routes and extremely hazardous workplaces
- For emergency lighting for 1 hrs. or 3 hrs. operating time
- Suitable for emergency lighting acc. to VDE 0108 or EN 50172
- Ambient temperature: 5 to 50 °C

Electrical features

- Mains voltage: 220–240 V ± 10%
- Mains frequency: 50–60 Hz
- Output voltage: 55 V, 105 V or 220 V
- Output power in emergency operation: 2.5–3 W

Rechargeable batteries

- Material: Iron phosphate (LiFePO4)
- Choice of the rechargeable battery depends on desired operating time and installation position.
- Charging time of rechargeable batteries: up to 24 hrs. depending on the capacity

Safety features

- For luminaires of protection class I
- Degree of protection: IP20
- SELV* (186804, 186805, 186806, 186807)
- Surge protection (186804, 186805, 186806, 186807): 3.75 kV
- Metal casing must be earthed using two fixing screws

Status LED

- Intermittent green: battery regeneration after commissioning as well as after each battery replacement
- Permanent green: battery correctly connected, battery charged
- Off: defective battery charge, battery not connected, battery totally flat, defective emergency lighting unit or in emergency operation

Packaging units

Ref. No.	Packaging unit		
	Pieces per box	Boxes per pallet	Weight g
186804	50	56	109
186805	50	56	109
186806	50	56	109
186807	50	56	109
186808	50	56	109
186809	50	56	109

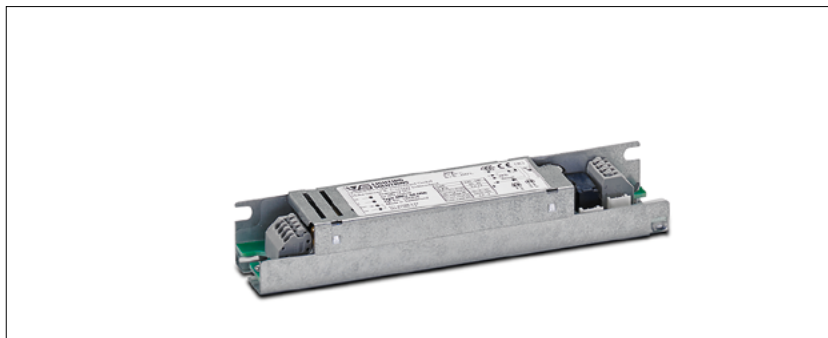

Dimensions

- Casing: M66
- Length: 150 mm
- Width: 30.2 mm
- Height: 22.1 mm

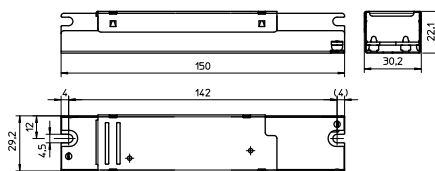

LED

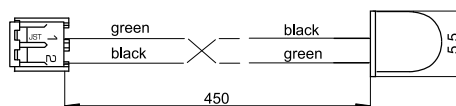

Used standards

- EN 60598-2:22
- EN 61347-2:7
- EN 62384



Product guarantee

- 5 years
- The conditions for the Product Guarantee of the Vossloh-Schwabe Group shall apply as published on our homepage (www.vossloh-schwabe.com). We will be happy to send you these conditions upon request.

The values contained in this data sheet can change due to technical innovations. Any such changes will be made without separate notification.

LED Emergency Lighting Devices – Emergency Basic

Electrical characteristics

Type	Ref. No. EM gear	Ref. No. Battery	Battery		Nominal emergency operation period hrs.	Output power in emergency operation (W)	Min. lumen in emergency operation* (lm)	Output voltage	
			Type	Shape				V	V max.
M66 – Dimensions (LxWxH): 150x30.2x22.1 mm									
EMCc 180.007	186805	183204	3,2 V/4,5 Ah C	Compact	3	2.5–3	250	12–55	60
			3,2V/4,5 Ah L	Linear	3				
EMCc 180.009	186807	183204	3,2 V/4,5 Ah C	Compact	3	2.5–3	250	20–105	120
			3,2 V/4,5 Ah L	Linear	3				
EMCc 180.011	186809	183204	3,2 V/4,5 Ah C	Compact	3	2.5–3	250	100–220	300
			3,2 V/4,5 Ah L	Linear	3				
EMCc 60.006	186804	183202	3,2V/3 Ah C	Compact	1	2.5–3	250	12–55	60
			3,2V/3 Ah L	Linear	1				
EMCc 60.008	186806	183202	3,2V/3 Ah C	Compact	1	2.5–3	250	20–105	120
			3,2V/3 Ah L	Linear	1				
EMCc 60.010	186808	183202	3,2V/3 Ah C	Compact	1	2.5–3	250	100–220	300
			3,2V/3 Ah L	Linear	1				

* at 100 lm/W per LED unit

Product labels

VS LIGHTING SOLUTIONS
Vossloh-Schwabe Deutschland GmbH
Hohe Steinert 8, D-58509 Lüdenscheid

Emergency Unit for LED module
Type EMCc 60.006
Ref.-No. 186804
Made in Switzerland

EN 60598-2-22
EN 61347-2-7

SELV tc= 65°C ta= 5...+50°C	
U _N (V)	220...240
f _N (Hz)	50...60
Batt Life PO ₂ (V/Ah)	3,2 / 3
Operating time (h)	1
LED voltage (V)	U=12...55
No load voltage (V)	U _{max} =60
Power supply (W)	2,5...3

VS LIGHTING SOLUTIONS
Vossloh-Schwabe Deutschland GmbH
Hohe Steinert 8, D-58509 Lüdenscheid

Emergency Unit for LED module
Type EMCc 180.009
Ref.-No. 186807
Made in Switzerland

EN 60598-2-22
EN 61347-2-7

SELV tc= 65°C ta= 5...+50°C	
U _N (V)	220...240
f _N (Hz)	50...60
Batt Life PO ₂ (V/Ah)	3,2 / 4,5
Operating time (h)	3
LED voltage (V)	U=20...105
No load voltage (V)	U _{max} =120
Power supply (W)	2,5...3

VS LIGHTING SOLUTIONS
Vossloh-Schwabe Deutschland GmbH
Hohe Steinert 8, D-58509 Lüdenscheid

Emergency Unit for LED module
Type EMCc 180.007
Ref.-No. 186805
Made in Switzerland

EN 60598-2-22
EN 61347-2-7

SELV tc= 65°C ta= 5...+50°C	
U _N (V)	220...240
f _N (Hz)	50...60
Batt Life PO ₂ (V/Ah)	3,2 / 3
Operating time (h)	3
LED voltage (V)	U=12...55
No load voltage (V)	U _{max} =60
Power supply (W)	2,5...3

VS LIGHTING SOLUTIONS
Vossloh-Schwabe Deutschland GmbH
Hohe Steinert 8, D-58509 Lüdenscheid

Emergency Unit for LED module
Type EMCc 60.010
Ref.-No. 186808
Made in Switzerland

EN 60598-2-22
EN 61347-2-7

SELV tc= 65°C ta= 5...+30°C	
U _N (V)	220...240
f _N (Hz)	50...60
Batt Life PO ₂ (V/Ah)	3,2 / 3
Operating time (h)	1
LED voltage (V)	U=100...220
No load voltage (V)	U _{max} =300
Power supply (W)	2,5...3

VS LIGHTING SOLUTIONS
Vossloh-Schwabe Deutschland GmbH
Hohe Steinert 8, D-58509 Lüdenscheid

Emergency Unit for LED module
Type EMCc 60.008
Ref.-No. 186806
Made in Switzerland

EN 60598-2-22
EN 61347-2-7

SELV tc= 65°C ta= 5...+50°C	
U _N (V)	220...240
f _N (Hz)	50...60
Batt Life PO ₂ (V/Ah)	3,2 / 3
Operating time (h)	1
LED voltage (V)	U=20...105
No load voltage (V)	U _{max} =120
Power supply (W)	2,5...3

VS LIGHTING SOLUTIONS
Vossloh-Schwabe Deutschland GmbH
Hohe Steinert 8, D-58509 Lüdenscheid

Emergency Unit for LED module
Type EMCc 180.011
Ref.-No. 186809
Made in Switzerland

EN 60598-2-22
EN 61347-2-7

SELV tc= 65°C ta= 5...+30°C	
U _N (V)	220...240
f _N (Hz)	50...60
Batt Life PO ₂ (V/Ah)	3,2 / 4,5
Operating time (h)	3
LED voltage (V)	U=100...220
No load voltage (V)	U _{max} =300
Power supply (W)	2,5...3

The values contained in this data sheet can change due to technical innovations. Any such changes will be made without separate notification.

Emergency Smart

With self-diagnosis function

Product features

- Designed for installation in LED luminaires for safety lighting for rescue routes and extremely hazardous workplaces
- For emergency lighting for 1 hrs. or 3 hrs. operating time
- Suitable for emergency lighting acc. to VDE 0108 or EN 50172
- With self-diagnosis function acc. to EN 62034
- Ambient temperature: 5 to 50 °C

Electrical features

- Mains voltage: 220–240 V ± 10%
- Mains frequency: 50–60 Hz
- Output voltage: 55 V, 105 V or 220 V
- Output power in emergency operation: 2.5–3 W

Rechargeable batteries

- Material: Iron phosphate (LiFePO₄)
- Choice of the rechargeable battery depends on desired operating time and installation position.
- Charging time of rechargeable batteries: up to 24 hrs. depending on the capacity

Safety features

- For luminaires of protection classes I and IIa
- Degree of protection: IP20
- SELV* (186810, 186811, 186812, 186813)
- Surge protection (186810, 186811, 186812, 186813): 3.75 kV

Status LED

- Intermittent green: battery regeneration after commissioning as well as after each battery replacement
- Permanent green: battery correctly connected, battery charged or self-test operation
- Flashing red: defective battery charge, battery not connected or battery capacity too low
- Flashing intermittent red: defective or unconnected LED luminaire unit
- Off: battery totally flat, defective emergency lighting unit or in emergency operation

Packaging units

Ref. No.	Packaging unit		
	Pieces per box	Boxes per pallet	Weight g
186810	50	56	83
186811	50	56	83
186812	50	56	83
186813	50	56	83
186814	50	56	83
186815	50	56	83



Dimensions

- Casing: K67
- Length: 177 mm
- Width: 30 mm
- Height: 21.5 mm

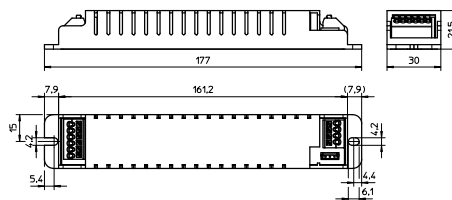

LED

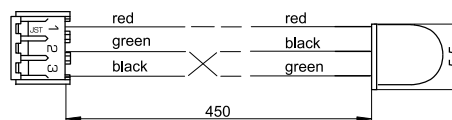

Used standards

- EN 60598-2:22
- EN 61347-2:7
- EN 62034
- EN 62384



Product guarantee

- 5 years
- The conditions for the Product Guarantee of the Vossloh-Schwabe Group shall apply as published on our homepage (www.vossloh-schwabe.com). We will be happy to send you these conditions upon request.

The values contained in this data sheet can change due to technical innovations. Any such changes will be made without separate notification.

LED Emergency Lighting Devices – Emergency Smart

Electrical characteristics

Type	Ref. No. EM gear	Ref. No. Battery	Battery		Nominal emergency operation period hrs.	Output power in emergency operation (W)	Min. lumen in emergency operation* (lm)	Output voltage	
			Type	Shape				V	V max.
K67 – Dimensions (LxWxH): 177x30x21.5 mm									
EMCc 180.013	186811	183204	3,2 V/4,5 Ah C	Compact	3	2.5–3	250	12–55	60
		183205	3,2V/4,5 Ah L	Linear	3				
EMCc 180.015	186813	183204	3,2 V/4,5 Ah C	Compact	3	2.5–3	250	20–105	120
		183205	3,2 V/4,5 Ah L	Linear	3				
EMCc 180.016	186815	183204	3,2 V/4,5 Ah C	Compact	3	2.5–3	250	100–220	300
		183205	3,2 V/4,5 Ah L	Linear	3				
EMCc 60.012	186810	183202	3,2V/3 Ah C	Compact	1	2.5–3	250	12–55	60
		183203	3,2V/3 Ah L	Linear	1				
EMCc 60.014	186812	183202	3,2V/3 Ah C	Compact	1	2.5–3	250	20–105	120
		183203	3,2V/3 Ah L	Linear	1				
EMCc 60.016	186814	183202	3,2V/3 Ah C	Compact	1	2.5–3	250	100–220	300
		183203	3,2V/3 Ah L	Linear	1				

* at 100 lm/W per LED unit

Product labels

Vossloh-Schwabe Deutschland GmbH
Hohe Steinert 8, D-58509 Lüdenscheid
Emergency Unit for LED module
Type EMCc60.012
Ref.-No. 186810
Made in Switzerland

U _N [V]	220...240
f _N [Hz]	50...60
Batt Life PO ₄ (V/Ah)	3,2 / 3
Operating time [h]	1
LED voltage [V]	U=12...55
No load voltage [V]	U _{max} =60
Power supply [W]	2,5...3

2'382'035 SELV
t_c = 65°C
t_a = 5...+50°C
Automatic self-testing mode
EN 60598-2-22
EN 61347-2-7
EN 62034

Vossloh-Schwabe Deutschland GmbH
Hohe Steinert 8, D-58509 Lüdenscheid
Emergency Unit for LED module
Type EMCc180.013
Ref.-No. 186811
Made in Switzerland

U _N [V]	220...240
f _N [Hz]	50...60
Batt Life PO ₄ (V/Ah)	3,2 / 4,5
Operating time [h]	3
LED voltage [V]	U=12...55
No load voltage [V]	U _{max} =60
Power supply [W]	2,5...3

2'381'911 SELV
t_c = 65°C
t_a = 5...+50°C
Automatic self-testing mode
EN 60598-2-22
EN 61347-2-7
EN 62034

Vossloh-Schwabe Deutschland GmbH
Hohe Steinert 8, D-58509 Lüdenscheid
Emergency Unit for LED module
Type EMCc60.014
Ref.-No. 186812
Made in Switzerland

U _N [V]	220...240
f _N [Hz]	50...60
Batt Life PO ₄ (V/Ah)	3,2 / 3
Operating time [h]	1
LED voltage [V]	U=20...105
No load voltage [V]	U _{max} =120
Power supply [W]	2,5...3

2'382'090 SELV
t_c = 65°C
t_a = 5...+50°C
Automatic self-testing mode
EN 60598-2-22
EN 61347-2-7
EN 62034

Vossloh-Schwabe Deutschland GmbH
Hohe Steinert 8, D-58509 Lüdenscheid
Emergency Unit for LED module
Type EMCc180.015
Ref.-No. 186813
Made in Switzerland

U _N [V]	220...240
f _N [Hz]	50...60
Batt Life PO ₄ (V/Ah)	3,2 / 4,5
Operating time [h]	3
LED voltage [V]	U=20...105
No load voltage [V]	U _{max} =120
Power supply [W]	2,5...3

2'381'912 SELV
t_c = 65°C
t_a = 5...+50°C
Automatic self-testing mode
EN 60598-2-22
EN 61347-2-7
EN 62034

Vossloh-Schwabe Deutschland GmbH
Hohe Steinert 8, D-58509 Lüdenscheid
Emergency Unit for LED module
Type EMCc60.016
Ref.-No. 186814
Made in Switzerland

U _N [V]	220...240
f _N [Hz]	50...60
Batt Life PO ₄ (V/Ah)	3,2 / 3
Operating time [h]	1
LED voltage [V]	U=100...220
No load voltage [V]	U _{max} =300
Power supply [W]	2,5...3

2'382'036 SELV
t_c = 65°C
t_a = 5...+50°C
Automatic self-testing mode
EN 60598-2-22
EN 61347-2-7
EN 62034

Vossloh-Schwabe Deutschland GmbH
Hohe Steinert 8, D-58509 Lüdenscheid
Emergency Unit for LED module
Type EMCc180.016
Ref.-No. 186815
Made in Switzerland

U _N [V]	220...240
f _N [Hz]	50...60
Batt Life PO ₄ (V/Ah)	3,2 / 4,5
Operating time [h]	3
LED voltage [V]	U=100...220
No load voltage [V]	U _{max} =300
Power supply [W]	2,5...3

2'381'913 SELV
t_c = 65°C
t_a = 5...+50°C
Automatic self-testing mode
EN 60598-2-22
EN 61347-2-7
EN 62034

The values contained in this data sheet can change due to technical innovations. Any such changes will be made without separate notification.

Emergency Smart DALI

With self-diagnosis function

Product features

- Designed for installation in LED luminaires for safety lighting for rescue routes and extremely hazardous workplaces
- For emergency lighting for 1 hrs. or 3 hrs. operating time
- Suitable for emergency lighting acc. to VDE 0108 or EN 50172
- With self-diagnosis function acc. to EN 62034
- Ambient temperature: 5 to 50 °C



Electrical features

- Mains voltage: 220–240 V ± 10%
- Mains frequency: 50–60 Hz
- Output voltage: 55 V, 105 V or 220 V
- Output power in emergency operation: 2.5–3 W

Dimensions

- Casing: K67
- Length: 177 mm
- Width: 30 mm
- Height: 21.5 mm

Used standards

- EN 60598-2-22
- EN 61347-2-7
- EN 62034
- EN 62384

Rechargeable batteries

- Material: Iron phosphate (LiFePO4)
- Choice of the rechargeable battery depends on desired operating time and installation position.
- Charging time of rechargeable batteries: up to 24 hrs. depending on the capacity

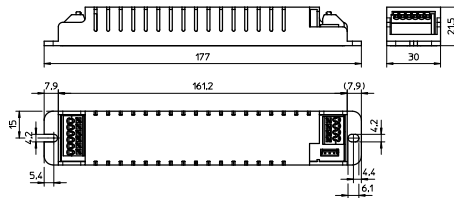

Safety features

- For luminaires of protection classes I and IIa
- Degree of protection: IP20
- SELV (187064, 187065, 187067, 187068)
- DALI
- Surge protection (187064, 187065, 187067, 187068): 3.75 kV

LED

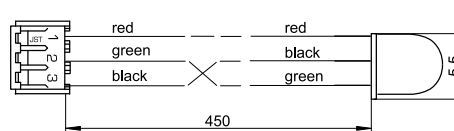

Status LED

- Intermittent green: battery regeneration after commissioning as well as after each battery replacement
- Permanent green: battery correctly connected, battery charged or self-test operation
- Flashing red: defective battery charge, battery not connected or battery capacity too low
- Flashing intermittent red: defective or unconnected LED luminaire unit
- Off: battery totally flat, defective emergency lighting unit or in emergency operation

Product guarantee

- 5 years
- The conditions for the Product Guarantee of the Vossloh-Schwabe Group shall apply as published on our homepage (www.vossloh-schwabe.com). We will be happy to send you these conditions upon request.

Packaging units

Ref. No.	Packaging unit		Weight g
	Pieces per box	Boxes per pallet	
187064	40	56	86
187065	40	56	86
187066	40	56	86
187067	40	56	86
187068	40	56	86
187069	40	56	86

The values contained in this data sheet can change due to technical innovations. Any such changes will be made without separate notification.

LED Emergency Lighting Devices – Emergency Smart

Electrical characteristics

Type	Ref. No. EM gear	Ref. No. Battery	Battery		Nominal emergency operation period hrs.	Output power in emergency operation (W)	Min. lumen in emergency operation* (lm)	Output voltage	
			Type	Shape				V	V max.
K67 – Dimensions (LxWxH): 177x30x21.5 mm									
EMCd 180.020	187064	183204	3,2 V/4,5 Ah C	Compact	3	2,5–3	250	12–55	60
		183205	3,2V/4,5 Ah L	Linear	3				
EMCd 180.021	187065	183204	3,2 V/4,5 Ah C	Compact	3	2,5–3	250	20–105	120
		183205	3,2 V/4,5 Ah L	Linear	3				
EMCd 180.022	187066	183204	3,2 V/4,5 Ah C	Compact	3	2,5–3	250	100–220	300
		183205	3,2 V/4,5 Ah L	Linear	3				
EMCd 60.023	187067	183202	3,2V/3 Ah C	Compact	1	2,5–3	250	12–55	60
		183203	3,2V/3 Ah L	Linear	1				
EMCd 60.024	187068	183202	3,2V/3 Ah C	Compact	1	2,5–3	250	20–105	120
		183203	3,2V/3 Ah L	Linear	1				
EMCd 60.025	187069	183202	3,2V/3 Ah C	Compact	1	2,5–3	250	100–220	300
		183203	3,2V/3 Ah L	Linear	1				

* at 100 lm/W per LED unit

Product labels

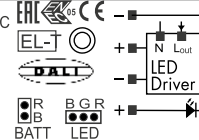
 LIGHTING SOLUTIONS Vossloh-Schwabe Deutschland GmbH Hohe Steinert 8, D-58509 Lüdenscheid Digital addressable (Dali) Emergency Unit for LED module Type EMCd 180.020 Ref.-No. 187064 Made in Switzerland 2'381'812	U _N (V)	220...240	t _c = 65°C t _a = 5...+50	
	f _s (Hz)	50...60		
	Batt Life/PQ (V/Ah)	3,2 / 4,5		
	Operating time (h)	3		
	LED voltage (V)	U=12 - 55		
	No-load voltage (V)	U _{max} =60		
	Power supply (W)	2,5...3		

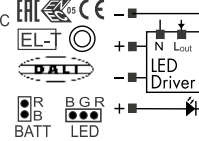
 LIGHTING SOLUTIONS Vossloh-Schwabe Deutschland GmbH Hohe Steinert 8, D-58509 Lüdenscheid Digital addressable (Dali) Emergency Unit for LED module Type EMCd 180.021 Ref.-No. 187065 Made in Switzerland 2'381'813	U _N (V)	220...240	t _c = 65°C t _a = 5...+50	
	f _s (Hz)	50...60		
	Batt Life/PQ (V/Ah)	3,2 / 4,5		
	Operating time (h)	3		
	LED voltage (V)	U=20 - 105		
	No-load voltage (V)	U _{max} =120		
	Power supply (W)	2,5...3		

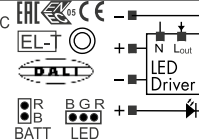
 LIGHTING SOLUTIONS Vossloh-Schwabe Deutschland GmbH Hohe Steinert 8, D-58509 Lüdenscheid Digital addressable (Dali) Emergency Unit for LED module Type EMCd 180.022 Ref.-No. 187066 Made in Switzerland 2'381'814	U _N (V)	220...240	t _c = 65°C t _a = 5...+50	
	f _s (Hz)	50...60		
	Batt Life/PQ (V/Ah)	3,2 / 4,5		
	Operating time (h)	3		
	LED voltage (V)	U=100 - 220		
	No-load voltage (V)	U _{max} =300		
	Power supply (W)	2,5...3		

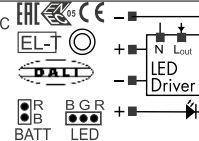
 LIGHTING SOLUTIONS Vossloh-Schwabe Deutschland GmbH Hohe Steinert 8, D-58509 Lüdenscheid Digital addressable (Dali) Emergency Unit for LED module Type EMCd 60.023 Ref.-No. 187067 Made in Switzerland 2'382'155	U _N (V)	220...240	t _c = 65°C t _a = 5...+50	
	f _s (Hz)	50...60		
	Batt Life/PQ (V/Ah)	3,2 / 3		
	Operating time (h)	1		
	LED voltage (V)	U=12 - 55		
	No-load voltage (V)	U _{max} =60		
	Power supply (W)	2,5...3		

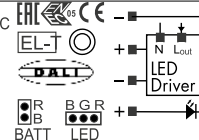
 LIGHTING SOLUTIONS Vossloh-Schwabe Deutschland GmbH Hohe Steinert 8, D-58509 Lüdenscheid Digital addressable (Dali) Emergency Unit for LED module Type EMCd 60.024 Ref.-No. 187068 Made in Switzerland 2'382'156	U _N (V)	220...240	t _c = 65°C t _a = 5...+50	
	f _s (Hz)	50...60		
	Batt Life/PQ (V/Ah)	3,2 / 3		
	Operating time (h)	1		
	LED voltage (V)	U=20 - 105		
	No-load voltage (V)	U _{max} =120		
	Power supply (W)	2,5...3		

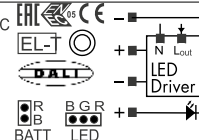
 LIGHTING SOLUTIONS Vossloh-Schwabe Deutschland GmbH Hohe Steinert 8, D-58509 Lüdenscheid Digital addressable (Dali) Emergency Unit for LED module Type EMCd 60.025 Ref.-No. 187069 Made in Switzerland 2'382'157	U _N (V)	220...240	t _c = 65°C t _a = 5...+50	
	f _s (Hz)	50...60		
	Batt Life/PQ (V/Ah)	3,2 / 3		
	Operating time (h)	1		
	LED voltage (V)	U=100 - 220		
	No-load voltage (V)	U _{max} =300		
	Power supply (W)	2,5...3		

The values contained in this data sheet can change due to technical innovations. Any such changes will be made without separate notification.

DALI and self tests for single battery application

Operating mode of the Emergency lighting unit	DALI driver (main supply) in combination with regular emergency lighting control gear	DALI driver (mains supply) in conjunction with DALI emergency lighting unit
From commissioning and after battery change (regeneration) repeating three times: 24h charging time with subsequent discharge	The luminaire can be controlled during the charging time via DALI as well as a switched phase controlled. The DALI driver is disconnected for discharging (by the emergency lighting unit) from the power supply and the lamp. - DALI driver fault message, if applicable. The illuminant shines inevitably with output power in the emergency operation. The discharge starts three times by the emergency lighting unit, each time after 24h charging time.	The luminaire can be controlled via DALI as well as a switched phase controlled. DALI emergency lighting units do not perform automatic battery regeneration! - DALI driver fault message, if applicable. The illuminant shines inevitably with output power in the emergency operation. The discharge starts three times by the emergency lighting unit, each time after 24h charging time.
Capacity test Discharge for at least the time of the rated operating time	The DALI driver is disconnected (by the emergency lighting control gear for the test) from the mains supply and the light source. - DALI driver fault message, if applicable. The lamp necessarily operates with emergency power. The test is started autonomously by the emergency lighting unit every 7th day.	The DALI driver is disconnected (by the emergency lighting control gear for the test) from the mains supply and the light source. - DALI driver fault message, if applicable. The lamp necessarily operates with output power in emergency mode. The test is started autonomously by the emergency lighting unit every 7th day.
Function test Discharge for 1% of the rated operating time	The DALI driver is disconnected (by the emergency lighting control gear for the test) from the mains supply and the light source. - DALI driver fault message, if applicable. The lamp necessarily operates with output power in emergency mode. The test is started autonomously by the emergency lighting unit every 7th day.	The DALI driver is disconnected (by the emergency lighting control gear for the test) from the mains supply and the light source. - DALI driver fault message, if applicable. The lamp necessarily operates with output power in emergency mode. The test is started autonomously by the emergency lighting unit every 7th day.
Regular operation after Test Automatic charging	The luminaire can be controlled via DALI as well as a switched phase. However, it is possible that DALI control commands were not received by the driver during the test or the driver changes to its start state defined by the manufacturer (mains return). – possibly unknown operating state of the DALI driver.	The luminaire can be controlled via DALI as well as a switched phase. However, it is possible that DALI control commands were not received by the driver during the test or the driver changes to its start state defined by the manufacturer (mains return). – possibly unknown operating state of the DALI driver.

The values contained in this data sheet can change due to technical innovations. Any such changes will be made without separate notification.

Linear Batterys for Emergency Basic and Smart

LiFePO4 rechargeable batteries

Charging time of rechargeable batteries: up to 24 hrs. depending on the capacity
With connection leads (length: 250 mm) and plug;
max. lead length: 750 mm

Choice of the rechargeable battery depends on desired operating time and installation position.

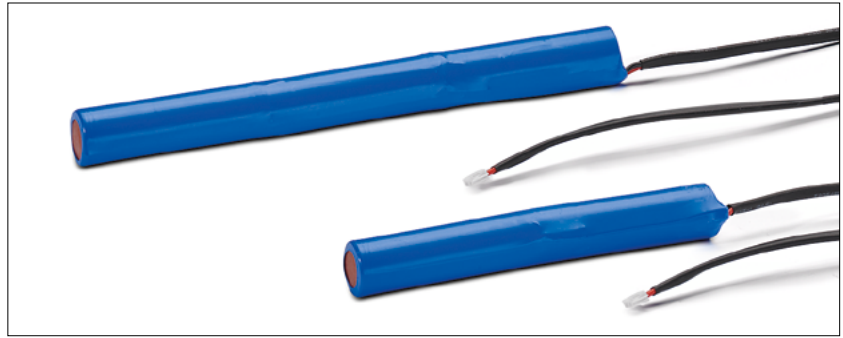

Type	Ref. No.	ELUBAT No.	Dimensions			Nominal operating period hrs.	Weight g	Packaging unit	
			Ø mm	Length mm				Pieces per box	Boxes per pallet

Linear rechargeable batteries

3,2 V/4,5 Ah L	183205	275809	19	196	3	130	40	32
3,2 V/3 Ah L	183203	275802	19	131	1	89	60	32

Storage time rechargeable batteries: max. 1 year; storage temperature: 0–50 °C

HOLDERS for linear rechargeable batteries for emergency LED lighting modules

Sold separately

Two holders per battery required.

Material: PBT

For linear batteries 183203, 183205

Weight: 4 g, packaging unit: 175 pcs.

Type: Batteryholder LiFePO4

Ref. No.: 183206

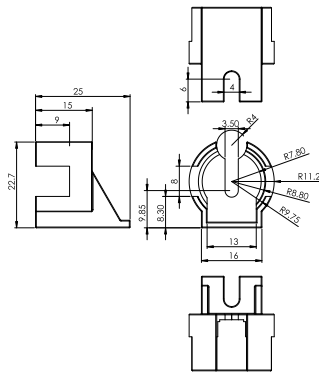

Product guarantee

- 3 years in combination with Emergency Smart
- 1 year in combination with Emergency Basic
- The conditions for the Product Guarantee of the Vossloh-Schwabe Group shall apply as published on our homepage (www.vossloh-schwabe.com). We will be happy to send you these conditions upon request.

Compact Batteries for Emergency Basic and Smart

LiFePO4 rechargeable batteries

Charging time of rechargeable batteries: up to 24 hrs. depending on the capacity
With connection leads (length: 250 mm) and plug;
max. lead length: 750 mm

Choice of the rechargeable battery depends on desired operating time and installation position.

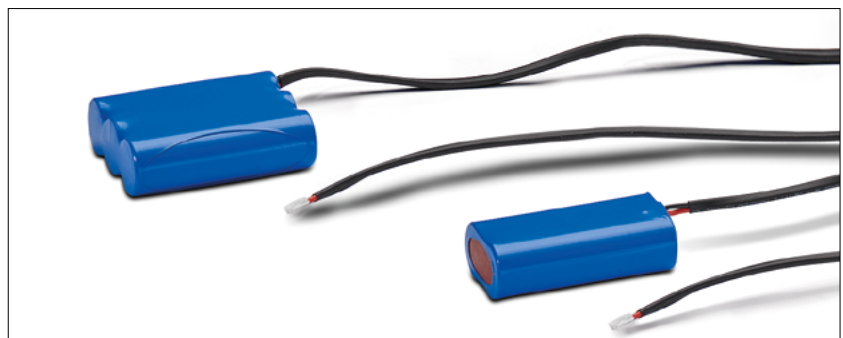

Type	Ref. No.	ELUBAT No.	Dimensions			Nominal operating period (hrs.)	Weight g	Packaging unit	
			Length mm	Width mm	Height mm			Pieces per box	Boxes per pallet

Compact rechargeable batteries

3,2 V/4,5 Ah C	183204	275813	55	19	65	3	130	36	32
3,2 V/3 Ah C	183202	275810	36	18	65	1	89	60	32

Storage time rechargeable batteries: max. 1 year; storage temperature: 0–50 °C

Product guarantee

- 3 years in combination with Emergency Smart
- 1 year in combination with Emergency Basic
- The conditions for the Product Guarantee of the Vossloh-Schwabe Group shall apply as published on our homepage (www.vossloh-schwabe.com). We will be happy to send you these conditions upon request.

The values contained in this data sheet can change due to technical innovations. Any such changes will be made without separate notification.

Emergency Complete

With or without self-diagnosis function and integrated battery

Product features

- Designed for independent operation of LED luminaires for safety lighting for rescue routes and extremely hazardous workplaces
- For emergency lighting for 1 hrs. or 3 hrs. operating time
- Suitable for emergency lighting acc. to VDE 0108 or EN 50172
- With self-diagnosis function acc. to EN 62034 (186817, 186816)
- Ambient temperature: 5 to 50 °C
- Iron phosphate (LiFePO₄) rechargeable battery is built-in into the casing
- Charging time of rechargeable battery: up to 24 hrs. depending on the capacity

Electrical features

- Mains voltage: 220–240 V ± 10%
- Mains frequency: 50–60 Hz
- Output voltage: 55 V
- Output power in emergency operation: 2.5–3 W

Safety features

- For luminaires of protection classes I and II
- Degree of protection: IP20
- SELV
- Surge protection: 3.75 kV
- Earthing: complete emergency module does not have to be earthed.
The emergency lighting module features three earth terminals for an LED driver and LED unit, if required.

Status LED

- Intermittent green: battery regeneration after commissioning as well as after each battery replacement
- Permanent green: battery correctly connected, battery charged or self-test operation
- Flashing red: defective battery charge, battery not connected or battery capacity too low
- Flashing intermittent red: defective or unconnected LED luminaire unit
- Off: battery totally flat, defective emergency lighting unit or in emergency operation

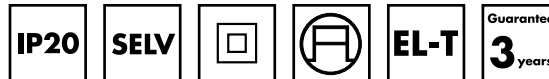

Dimensions

- Casing: K68
- Length: 290.1 mm
- Width: 80.8 mm
- Height: 41 mm

Used standards

- EN 60598-2:22
- EN 61347-2:7
- EN 62034
- EN 62384

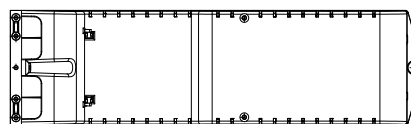
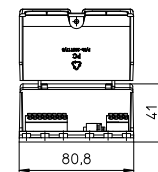
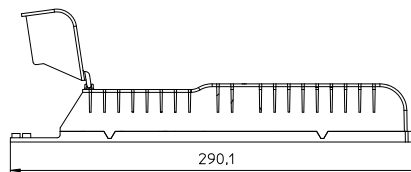
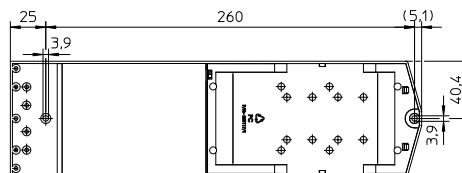

LED

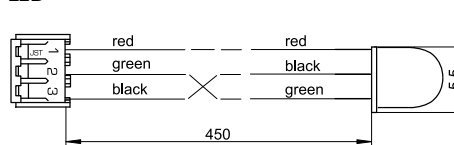

Product guarantee

- 3 years
- The conditions for the Product Guarantee of the Vossloh-Schwabe Group shall apply as published on our homepage (www.vossloh-schwabe.com). We will be happy to send you these conditions upon request.

Packaging units

Ref. No.	Packaging unit		Weight g
	Pieces per box	Boxes per pallet	
186817	20	24	389
186816	20	24	348
187077	20	24	389
187076	20	24	348

The values contained in this data sheet can change due to technical innovations. Any such changes will be made without separate notification.

LED Emergency Lighting Devices – Emergency Complete

Electrical characteristics







Type	Ref. No.	Battery		Nominal emergency operation period hrs.	Output power in emergency operation (W)	Min. lumen in emergency operation* (lm)	Output voltage	
		Type	Shape				V	V max.
K68 – Dimensions (LxWxH): 290.1x80.8x41 mm – with self-diagnosis function								
EMCc 180.019	186817	3,2 V/4,5 Ah C	Compact	3	2.5–3	250	12–55	60
EMCc 60.018	186816	3,2V/3 Ah C	Compact	1	2.5–3	250	12–55	60
K68 – Dimensions (LxWxH): 290.1x80.8x41 mm – without self-diagnosis function								
EMCc 180.027	187077	3,2 V/4,5 Ah C	Compact	3	2.5–3	250	12–55	60
EMCc 60.026	187076	3,2V/3 Ah C	Compact	1	2.5–3	250	12–55	60

* at 100 lm/W per LED unit

The values contained in this data sheet can change due to technical innovations. Any such changes will be made without separate notification.

LED Emergency Lighting Devices – Emergency Complete

Product labels

VS LIGHTING SOLUTIONS      

Vossloh-Schwabe Deutschland GmbH
Hohe Steinert 8, D-58509 Lüdenscheid

Emergency Unit
for LED module
Type EMCc 60.018
Ref.-No. 186816
Made in Switzerland





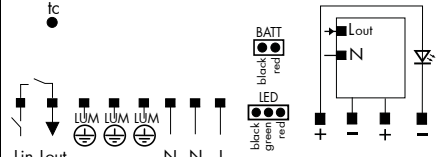

Automatic self-testing mode EN 60598-2-22
EN 61347-2-7
EN 62034

2'382'158

U_N (V)	220...240
f_N (Hz)	50...60
Batt LiFePO ₄ (V/Ah)	3,2 / 3
Operating time (h)	1
LED voltage (V)	U=12 - 55
No load voltage (V)	U _{max.} =60
Power supply (W)	2,5...3

SELV
t_c = 65°C
t_a = 5...+50°C



VS LIGHTING SOLUTIONS      

Vossloh-Schwabe Deutschland GmbH
Hohe Steinert 8, D-58509 Lüdenscheid

Emergency Unit
for LED module
Type EMCc 180.019
Ref.-No. 186817
Made in Switzerland





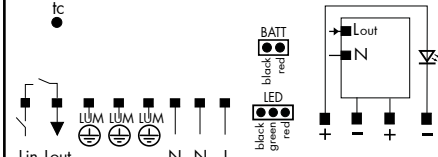

Automatic self-testing mode EN 60598-2-22
EN 61347-2-7
EN 62034

2'382'950

U_N (V)	220...240
f_N (Hz)	50...60
Batt LiFePO ₄ (V/Ah)	3,2 / 4,5
Operating time (h)	3
LED voltage (V)	U=12 - 55
No load voltage (V)	U _{max.} =60
Power supply (W)	2,5...3

SELV
t_c = 65°C
t_a = 5...+50°C



VS LIGHTING SOLUTIONS      

Vossloh-Schwabe Deutschland GmbH
Wasenstraße 25, D-73660 Urbach

Emergency Unit
for LED module
Type EMCc 60.026
Ref.-No. 187076
Made in Switzerland





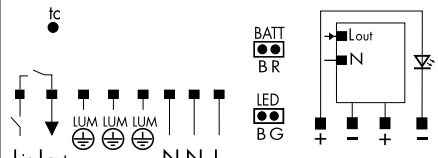

Automatic self-testing mode EN 60598-2-22
EN 61347-2-7

2'386'023

U_N (V)	220...240
f_N (Hz)	50...60
Batt LiFePO ₄ (V/Ah)	3,2 / 3
Operating time (h)	1
LED voltage (V)	U=12 - 55
No load voltage (V)	U _{max.} =60
Power supply (W)	2,5...3

SELV
t_c = 65°C
t_a = 5...+50°C



VS LIGHTING SOLUTIONS      

Vossloh-Schwabe Deutschland GmbH
Wasenstraße 25, D-73660 Urbach

Emergency Unit
for LED module
Type EMCc 180.027
Ref.-No. 187077
Made in Switzerland

Automatic self-testing mode EN 60598-2-22
EN 61347-2-7

2'381'937

U_N (V)	220...240
f_N (Hz)	50...60
Batt LiFePO ₄ (V/Ah)	3,2 / 4,5
Operating time (h)	3
LED voltage (V)	U=12 - 55
No load voltage (V)	U _{max.} =60
Power supply (W)	2,5...3

SELV
t_c = 65°C
t_a = 5...+50°C

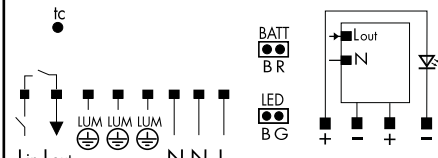

The values contained in this data sheet can change due to technical innovations. Any such changes will be made without separate notification.

Assembly and Safety Information

Installation must be carried out under observation of the relevant regulations and standards. Installation must be carried out in a voltage-free state (i.e. disconnection from the mains). The following advices must be observed; non-observance can result in the destruction of the LED emergency lighting devices, fire and/or other hazards.

Mandatory regulations

- DIN VDE 0100
- EN 60598-1

Emergency Basic

Mechanical mounting

- Mounting position: On an earthed metal surface
Installation in an LED luminaire of protection class I. Installation in a separate casing of protection class I or II.I
- Fastening/Earthing: Fix and/or earth using two suitable metal screws
- Installation of the battery and LED driver for constant switching:
Installation is possible within the same casing as the emergency lighting unit.
- Ambient temperature of the battery: max. 50 °C
- Length of the status LED lead: 400 mm

Electrical installation

- Connection terminals: Push-in terminals for leads of 0.5-1.5 mm²
- Stripped length: 8.5-10 mm
- Battery connection: Push-in connection with cables (length: 250 mm) (red = + / black = -), max. extension to 750 mm
- Battery discharge current:
The deep discharge protection of all lithium ion batteries is lower than 10 µA. This makes deliveries with connected battery possible, as long as no logistics restrictions apply.
- Polarity:
Please ensure the correct polarity of the leads prior to commissioning. Reversed polarity can destroy the modules.
- Secondary load (LED):
The sum of forward voltages of LED loads has to be within the tolerances which are mentioned in the table "Electrical Characteristics" in this data sheet.

• Wiring:

During mains-powered operation, the current that flows into the LED luminaire is regulated by the LED driver.

During emergency lighting operation, the LED unit will be supplied by the battery. The current that is supplied by the battery during emergency lighting operation is converted into "LED current" by the Basic emergency lighting unit.

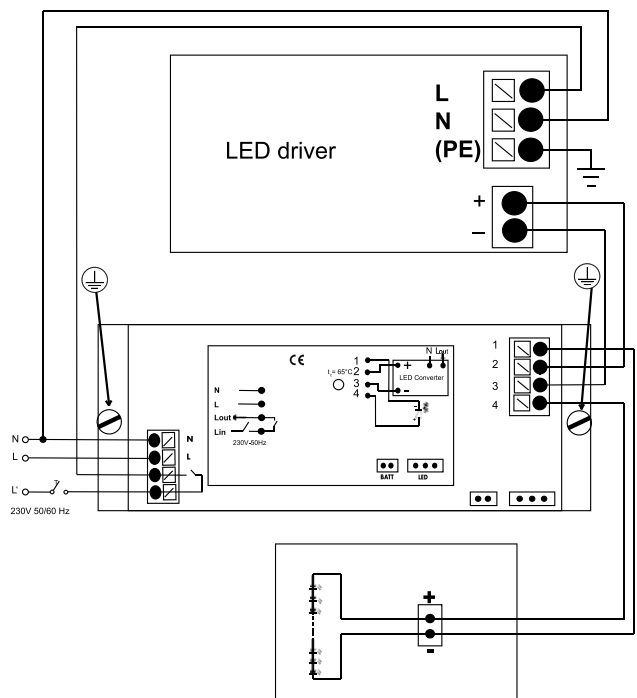

The values contained in this data sheet can change due to technical innovations. Any such changes will be made without separate notification.

Emergency Smart

Mechanical mounting

- Mounting position: In an LED luminaire or in a separate casing
- Fastening: Using two suitable screws
- Installation of the battery and LED driver for constant switching: Installation is possible within the same casing as the emergency lighting unit.
- Ambient temperature of the battery: max. 50 °C
- Length of the status LED lead: 400 mm

Electrical installation

- Connection terminals: Push-in terminals for leads of 0.5-1.5 mm²
- Stripped length: 8.5-10 mm
- Battery connection: Push-in connection with cables (length: 250 mm) (red = + / black = -), max. extension to 750 mm
- Battery discharge current: The deep discharge protection of all lithium ion batteries is lower than 10 µA. This makes deliveries with connected battery possible, as long as no logistics restrictions apply.
- Polarity: Please ensure the correct polarity of the leads prior to commissioning. Reversed polarity can destroy the modules.
- Secondary load (LED): The sum of forward voltages of LED loads has to be within the tolerances which are mentioned in the table "Electrical Characteristics" in this data sheet.
- Wiring: During mains-powered operation, the current that flows into the LED luminaire is regulated by the LED driver. During emergency lighting operation, the LED unit will be supplied by the battery. The current that is supplied by the battery during emergency lighting operation is converted into "LED current" by the Smart emergency lighting unit.

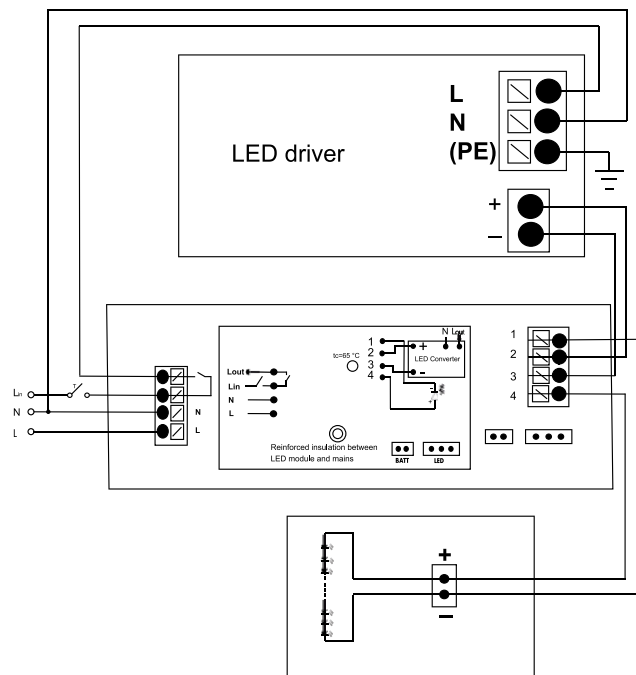

Self-testing function

- Self-test: Self-testing function in acc. with EN 62034 included. Every 8 days (random period between 8 and 8.25 days) an automatic self-test will be carried out. During this time, the LED unit will be supplied by the battery for 2 minutes via the emergency smart emergency lighting module. This ensures the LED unit and the correct functioning of the emergency lighting can be checked.
- Fatigue test: In addition, a quarterly fatigue test is carried out to check battery capacity. The first fatigue test is carried out 8 days after commissioning.
- Battery recovery: Within the space of about four days following commissioning and/or after a change of battery, three short charging and discharging cycles will be automatically carried out to regenerate the battery.

The values contained in this data sheet can change due to technical innovations. Any such changes will be made without separate notification.

Emergency Complete

Mechanical mounting – Emergency Complete

- Mounting position: Outside of an LED luminaire; suitable for independent operation
- Fastening: Using two suitable screws
- Ambient temperature of the battery: max. 50 °C
- Length of the status LED lead: 400 mm

Electrical installation

- Connection terminals: Push-in terminals for leads of 0.5-1.5 mm²
- Stripped length: 8.5-10 mm
- Battery connection: Push-in connection with cables (length: 250 mm) (red = + / black = -), max. extension to 750 mm
- Battery discharge current: The deep discharge protection of all lithium ion batteries is lower than 10 µA. This makes deliveries with connected battery possible, as long as no logistics restrictions apply.
- Polarity: Please ensure the correct polarity of the leads prior to commissioning. Reversed polarity can destroy the modules.
- Secondary load (LED): The sum of forward voltages of LED loads has to be within the tolerances which are mentioned in the table "Electrical Characteristics" in this data sheet.
- Wiring: The Emergency Complete casing is fitted with a lid for a cord grip. As shown in the circuit diagram, the following three leads must be connected to the mains terminal of the Emergency Complete unit:
 - mains cable (switched phase, direct phase, neutral and earth, if required for the driver and/or the LED unit)
 - LED driver cable (switched phase, neutral and earth, if required)
 - bus line (DALI)

During mains-powered operation, the current that flows into the LED luminaire is regulated by the LED driver.

During emergency lighting operation, the LED unit will be supplied by the battery.

The current that is supplied by the battery during emergency lighting operation is converted into "LED current" by the Complete emergency lighting unit.

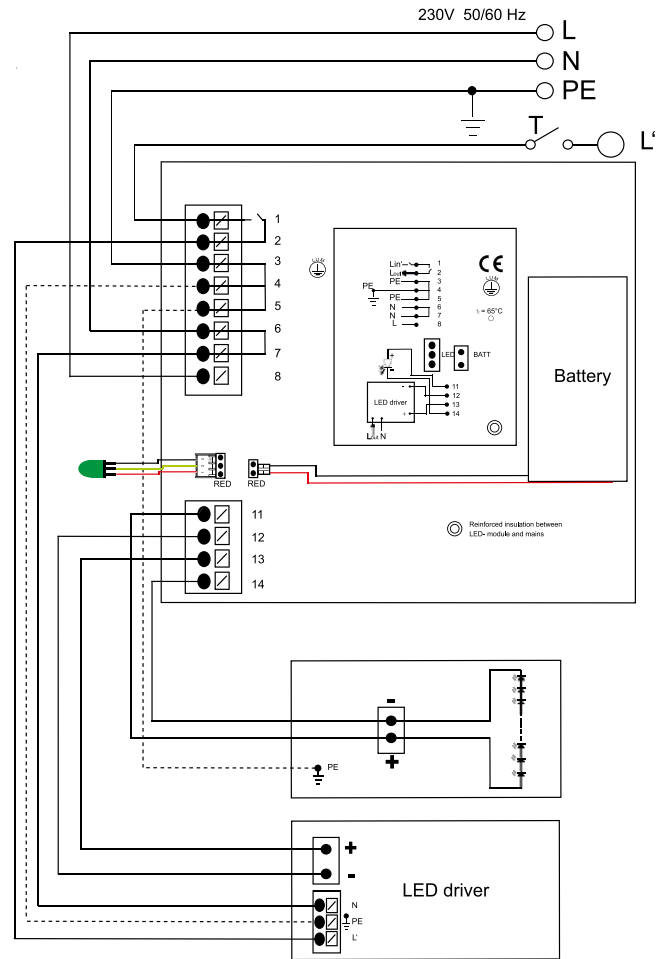

Self-testing function

- Self-test: Self-testing function in acc. with EN 62034 included. Every 8 days (random period between 8 and 8.25 days) an automatic self-test will be carried out. During this time, the LED unit will be supplied by the battery for 2 minutes via the emergency smart emergency lighting module. This ensures the LED unit and the correct functioning of the emergency lighting can be checked.
- Fatigue test: In addition, a quarterly fatigue test is carried out to check battery capacity. The first fatigue test is carried out 8 days after commissioning.
- Battery recovery: Within the space of about four days following commissioning and/or after a change of battery, three short charging and discharging cycles will be automatically carried out to regenerate the battery.

The values contained in this data sheet can change due to technical innovations. Any such changes will be made without separate notification.